



75
Azadi Ka
Amrit Mahotsav

**NATIONAL COMPANY LAW TRIBUNAL
CHANDIGARH BENCH
CORPORATE BHAWAN, PLOT NO. 4-B
GROUND FLOOR, SECTOR 27-B, MADHYA MARG,
CHANDIGARH-160019**

No.NCLT/Reg./FO/2023/2135...

Date..16.02.23

CP (CAA) No. 35/Chd/Hry/2022

**Under Sections 230 to 232 & Section 66
of the Companies Act, 2013 read with
Companies (Compromises,
Arrangements and Amalgamations)
Rules, 2016**

In the matter of Composite Scheme of Arrangement amongst:

To

- 1. Jindal Stainless Limited**
having its registered office at
O.P. Jindal Marg, Hisar- 125005, Haryana
CIN: L26922HR1980PLC010901
PAN: AABCJ1969M

... Petitioner Company No. 1 /
Amalgamated Company

- 2. Jindal Stainless (Hisar) Limited**
having its registered office at
O.P. Jindal Marg, Hisar - 125005, Haryana
CIN: L27205HR2013PLC049963
PAN: AAFCK5692N

... Petitioner Company No. 2 /
Amalgamating Company No. 1

- 3. JSL Lifestyle Limited**
having its registered office at
48th K.M. Stone, Delhi Rohtak Road,
Village Rohad, Tehsil Bahadurgarh, J
hajjar, Haryana-124507
CIN: U74920HR2003PLC035976
PAN: AAFCFA5161Q



... Petitioner Company No. 3 / Demerged Company/
Amalgamating Company No. 2

4. JSL Media Limited

having its registered office at
JSL Complex, O.P. Jindal Marg,
Hisar- 125005, Haryana
CIN: U70102HR2007PLC091299
PAN: AAACP5027F

... Petitioner Company No. 4 /
Amalgamating Company No. 3

5. Jindal Stainless Corporate Management Services Private Limited

having its registered office at
O.P. Jindal Marg, Hisar- 125005, Haryana
CIN: U74140HR2013PTC049340
PAN: AADCJ5227E

... Petitioner Company No. 5 /
Amalgamating Company No. 4

6. Jindal Lifestyle Limited

having its registered office at
C/o Jindal Stainless (Hisar) Limited,
O.P. Jindal Marg, Hisar- 125005, Haryana
CIN: U36109HR2020PLC091638
PAN: AAFCJ0452R

... Petitioner Company No. 6 /
Resulting Company

Please find enclosed herewith formal order as per Form No. CAA 7 of Companies (Compromises, Arrangements and Amalgamation) Rules, 2016 containing the directions of the Hon'ble National Company Law Tribunal, Chandigarh for compliance in terms of order dated 02.02.2023.

(Kartikeya Verma)
Registrar



FORM No. CAA.7
(Pursuant to section 232 and rule 20)
Before the National Company Law Tribunal,
Chandigarh Bench, Chandigarh

No.NCLT/Reg./FO/2023/.....

Date.....

CP (CAA) No. 35/Chd/Hry/2022

**Under Sections 230 to 232 & Section 66
of the Companies Act, 2013 read with
Companies (Compromises,
Arrangements and Amalgamations)
Rules, 2016**

In the matter of Composite Scheme of Arrangement amongst:

To

- 1. Jindal Stainless Limited**
having its registered office at
O.P. Jindal Marg, Hisar- 125005, Haryana
CIN: L26922HR1980PLC010901
PAN: AABCJ1969M

... Petitioner Company No. 1 /
Amalgamated Company

- 2. Jindal Stainless (Hisar) Limited**
having its registered office at
O.P. Jindal Marg, Hisar - 125005, Haryana
CIN: L27205HR2013PLC049963
PAN: AAFCK5692N

... Petitioner Company No. 2 /
Amalgamating Company No. 1

- 3. JSL Lifestyle Limited**
having its registered office at
48th K.M. Stone, Delhi Rohtak Road,
Village Rohad, Tehsil Bahadurgarh, J
hajjar, Haryana-124507
CIN: U74920HR2003PLC035976
PAN: AAFCA5161Q

... Petitioner Company No. 3 / Demerged Company/
Amalgamating Company No. 2

- 4. JSL Media Limited**



having its registered office at
JSL Complex, O.P. Jindal Marg,
Hisar- 125005, Haryana
CIN: U70102HR2007PLC091299
PAN: AAACP5027F

... Petitioner Company No. 4 /
Amalgamating Company No. 3

5. Jindal Stainless Corporate Management Services Private Limited

having its registered office at
O.P. Jindal Marg, Hisar- 125005, Haryana
CIN: U74140HR2013PTC049340
PAN: AADCJ5227E

... Petitioner Company No. 5 /
Amalgamating Company No. 4

6. Jindal Lifestyle Limited

having its registered office at
C/o Jindal Stainless (Hisar) Limited,
O.P. Jindal Marg, Hisar- 125005, Haryana
CIN: U36109HR2020PLC091638
PAN: AAFCJ0452R

... Petitioner Company No. 6 /
Resulting Company

Upon the above petition coming up for hearing on 02nd February, 2023 and upon reading the said petition, report submitted by the Income Tax Department and compliance affidavit submitted by the Petitioner Companies and hearing Learned Advocate for the petitioner companies as well as counsel for the Income Tax Department and after carefully perusing the records, the National company Law Tribunal approved the 'scheme' with the clarification that this order should not be construed as an order in any way granting exemption from payment of stamp duty, taxes or any other charges, if any, payment is due or required in accordance with law or in respect to any permission/compliance with any other requirement which may be specifically required under any law.

THIS TRIBUNAL DO FURTHER ORDER:

1. That all the property, rights and powers of the Amalgamating Companies (i.e., Petitioner Companies Nos. 2, 4 and 5 and Petitioner Company No. 3 post demerger of Demerged Undertaking (as defined in the Scheme of Arrangement) be transferred, without further act or deed, to the Amalgamated Company (Petitioner

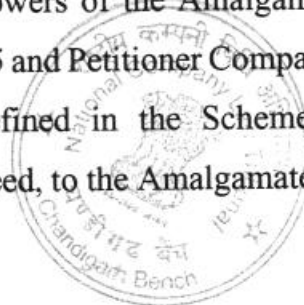

Handwritten signature or mark.

Company No. 1) and accordingly, the same shall pursuant to Sections 66, 230 & 232 of the Act, be transferred to and vested in the Amalgamated Company (Petitioner Company No. 1) for all the estate and interest of the Amalgamating Companies (i.e., Petitioner Companies Nos. 2, 4 and 5 and Petitioner Company No. 3 post demerger of Demerged Undertaking) but subject nevertheless to all charges now affecting the same; and

2. That all the liabilities and duties of the Amalgamating Companies (i.e., Petitioner Companies Nos. 2, 4 and 5 and Petitioner Company No. 3 post demerger of Demerged Undertaking) be transferred, without further act or deed, to the Amalgamated Company (Petitioner Company No. 1) and accordingly the same shall pursuant to Sections 66,230 to 232 of the Act, be transferred to and become the liabilities and duties of the Amalgamated Company (Petitioner Company No. 1);
3. All benefits, entitlements, incentives and concessions under incentive schemes and policies that the Amalgamating Companies (i.e., Petitioner Companies Nos. 2, 4 and 5 and Petitioner Company No. 3 post demerger of Demerged Undertaking) are entitled to include under Customs, Excise, Service Tax, VAT, Sales Tax, GST and Entry Tax and Income Tax laws, subsidy receivables from Government, grant from any governmental authorities, direct tax benefit/exemptions/deductions, shall, to the extent statutorily available and along with associated obligations, stand transferred to and be available to the Amalgamated Company (Petitioner Company No. 1) as if the Amalgamated Company (Petitioner Company 1) was originally entitled to all such benefits, entitlements, incentives and concessions;
4. All contracts, agreements, sanctions and permission of the Amalgamating Companies (i.e., Petitioner Companies Nos. 2, 4 and 5 and Petitioner Company No. 3 post demerger of Demerged Undertaking) which are subsisting or having effect immediately before the Effective Date, shall stand transferred to and vested in the Amalgamated Company (Petitioner Company No. 1) and be in full force and effect in favour of the Amalgamated Company (Petitioner Company No. 1) and may be enforced by or against it as fully and effectually as if, instead of the Amalgamating Companies (i.e., Petitioner Companies Nos. 2, 4 and 5 and Petitioner Company No. 3 post demerger of Demerged Undertaking), the

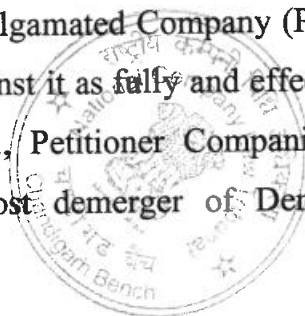

5

Amalgamated Company (Petitioner Company No. 1) had been a party or beneficiary or obliged thereto;

5. All the employees of the Amalgamating Companies (i.e., Petitioner Companies Nos. 2, 4 and 5 and Petitioner Company no. 3 post demerger of Demerged Undertaking) shall be deemed to have become the employees and the staff of the Amalgamated Company (Petitioner Company No. 1) with effect from the Appointed Date, and shall stand transferred to the Amalgamated Company (Petitioner Company No. 1) without any interruption of service and on the terms and conditions no less favourable than those on which they are engaged by the Amalgamating Companies (i.e., Petitioner Companies Nos. 2, 4 and 5 and Petitioner Company No. 3 post demerger of Demerged Undertaking), as on the Effective Date, including in relation to the level of remuneration and contractual and statutory benefits, incentive plans, terminal benefits, gratuity plans, provident plans and any other retirement benefits;
6. That all the property, rights and powers of the Demerged Undertaking of the Demerged Company (Petitioner Company No. 3) be transferred, without further act or deed, to the Resulting Company (Petitioner Company No.6) and accordingly, the same shall pursuant to Sections 230 & 232 and 66 of the Act, be transferred to and vested in the Resulting Company (Petitioner Company No.6) for all the estate and interest of the Demerged Undertaking of the Demerged Company(Petitioner Company No. 3) but subject nevertheless to all charges now affecting the same; and
7. That all the liabilities and duties of the Demerged Undertaking of the Demerged Company (Petitioner Company No.3) be transferred, without further act or deed, to the Resulting Company (Petitioner Company No. 6) and accordingly the same shall pursuant to Sections 66, 230 to 232 of the Act, be transferred to and become the liabilities and duties of the Resulting Company (Petitioner Company No.6);
8. All benefits, entitlements, incentives and concessions under incentive schemes and policies that the Demerged Undertaking of the Demerged Company (Petitioner Company No. 3) are entitled to include under Customs, Excise, Service Tax, VAT, Sales Tax, GST and Entry Tax and Income Tax laws, subsidy receivables from Government, grant from any governmental authorities, direct tax

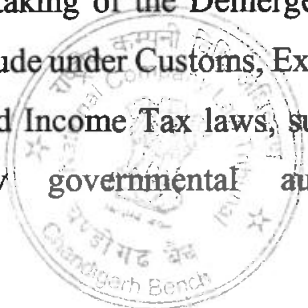

[Handwritten signature]

- benefit/exemptions/deductions, shall, to the extent statutorily available and along with associated obligations, stand transferred to and be available to the Resulting Company as if the Resulting Company (Petitioner Company No. 6) was originally entitled to all such benefits, entitlements, incentives and concessions;
9. All contracts agreements, sanctions and permission of the Demerged Undertaking of the Demerged Company (Petitioner Company No. 3) which are subsisting or having effect immediately before the Effective Date, shall stand transferred to and vested in the Resulting Company (Petitioner Company No. 6) and be in full force and effect in favour of the Resulting Company (Petitioner Company No. 6) and may be enforced by or against it as fully and effectually as if, instead of the Demerged Undertaking of the Demerged Company (Petitioner Company No. 3), the Resulting Company (Petitioner Company No. 6) had been a party or beneficiary or obliged thereto;
 10. All the employees of the Demerged Undertaking of the Demerged Company (Petitioner Company No. 3) shall be deemed to have become the employees and the staff of the Resulting Company (Petitioner Company No. 6) with effect from the Appointed Date, and shall stand transferred to the Resulting Company (Petitioner Company No. 6) without any interruption of service and on the terms and conditions no less favourable than those on which they are engaged by the Demerged Undertaking of the Demerged Company (Petitioner Company No. 3), as on the Effective Date, including in relation to the level of remuneration and contractual and statutory benefits, incentive plans, terminal benefits, gratuity plans, provident plans and any other retirement benefits;
 11. That the Appointed Date for the Scheme shall be the opening of business hours on 01.04.2020 as specified in the Scheme of Arrangement;
 12. That the legal proceedings or litigations if any, now pending by or against the Amalgamating Companies (i.e. Petitioner Companies Nos. 2, 4 and 5 and Petitioner Company No. 3 post demerger of Demerged Undertaking) be continued by or against the Amalgamated Company (Petitioner Company No. 1). Similarly, proceedings, if any, now pending by or against the Demerged Undertaking of the Demerged Company (Petitioner Company No. 3) be continued by or against the Resulting Company (Petitioner Company No. 6);

13. That as per the Scheme of Arrangement, the Amalgamated Company (Petitioner Company No. 1) and Resulting Company (Petitioner Company No. 6) shall without further application, allot shares of Amalgamated Company and Resulting Company to the shareholders of the Amalgamating Companies (i.e. Petitioner Companies Nos. 2, 4, 5 and 3 post demerger of Demerged Undertaking) and Demerged Company (Petitioner Company No. 3);
14. That the fee, if any, paid by the Amalgamating Companies (i.e., Petitioner Companies Nos. 2, 4 and 5 and Petitioner Company no. 3 post demerger of Demerged Undertaking) on their authorized capital shall be set off against any fees payable by the Transferee Company (Petitioner Company Nos. 1) on its authorized capital subsequent to the sanction of the Scheme of Arrangement;
15. That the carry forward and set off of accumulated losses in the Petitioner Companies, if any, shall be subject to applicable provisions of Income Tax including Section 72A and Section 79 of the Income Tax Act, 1961;
16. That the assessment under the Income Tax Act will be in accordance with the provisions of Section 170 (2A) of the Income Tax Act, 1961;
17. That the Amalgamated Company (Petitioner Company No. 1) shall comply with the provisions of section 13 of the Companies Act, 2013 to give the effect of change in object clause of the Amalgamated Company;
18. That the immovable properties of Amalgamating Company No.4 are to be transferred to the Transferee Company subject to all the procedure compliances as may be required under existing laws;
19. That the Amalgamated Company (Petitioner Company No. 1) and Resulting Company (Petitioner Company No. 6) shall file the revised memorandum and articles of association with the concerned Registrar of Companies and further make the requisite payments of the differential fee (if any) for the enhancement of authorized capital of the Amalgamated Company (Petitioner Company No. 1); after setting off the fees paid by the Amalgamating Companies (i.e., Petitioner Companies Nos. 2, 4 and 5 and Petitioner Company No. 3 post demerger of Demerged Undertaking);
20. That the Petitioner Companies shall, within 30 days after the date of receipt of this order, cause a certified copy of this order to be delivered to the concerned Registrar

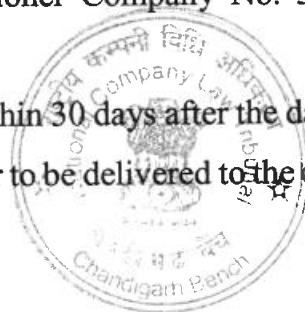

of Companies for registration and on such certified copy being so delivered, the Amalgamating Companies (i.e., Petitioner Companies Nos. 2, 4 and 5 and Petitioner Company No. 3 post demerger of Demerged Undertaking) shall be dissolved without undergoing the process of winding up. The concerned Registrar of Companies shall place all documents relating to the Amalgamating Companies (i.e., Petitioner Companies Nos. 2, 4 and 5 and Petitioner Company No. 3 post demerger of Demerged Undertaking) registered with him on the file relating to the said Transferee Company (Petitioner Company No. 1), and the files relating to the Companies and Amalgamated Company (Petitioner Company No. 1) shall be consolidated accordingly, as the case may be; and

21. That any person interested shall be at liberty to apply to this Tribunal in the above matter for any directions that may be necessary.

Dated: 02.02.2023
(By the Tribunal)

FREE OF COST COPY



(Kartikeya Verma)
Registrar
National Company Law Tribunal,
Chandigarh Bench

CERTIFIED TO BE TRUE COPY
OF THE ORIGINAL

SCHEDULE OF PROPERTIES

(attached as supplied by the Transferor Company)

No. 516

Date of Presentation
of application for Copy 13.02.23

No of Pages 9 pages

Copying Fee Nil

Registration & Postage Fee Nil

Total ₹ Nil

Date of Receipt &

Date of Preparation of Copy 16.02.23

Date of Delivery of Copy _____

DD / DR / AR / Court Officer
National Company Law Tribuna
Chandigarh Bench Chandigarh

4
7

ANNEXURE – A

SCHEDULE OF ASSETS OF
JINDAL STAINLESS CORPORATE MANAGEMENT
SERVICES ("AMALGAMATING COMPANY NO. 4")
PRIVATE LIMITED TO BE TRANSFERRED TO JINDAL
STAINLESS LIMITED ("AMALGAMATED COMPANY")

PART-I

DESCRIPTION OF THE FREEHOLD PROPERTY OF THE
AMALGAMATING COMPANY NO. 4 TO BE TRANSFERRED
TO AMALGAMATED COMPANY

Title Document	Property Location	Authority where registered
1. 60 apartments on different floors of Block No-2, of Springville Homes of Surekha Merlin Promoters Pvt Ltd having total super built up area of 46540 sq.ft (built up area of 37220 sq.ft) along with an undivided proportionate share of the land with exclusive right of use for	Property situated on a land measuring 4.970 acres District- Jajpur, PS-Jajpur Road, PS No-231, Tahsil- Danagadi, Sub- Registrar- Dollipur under	The Property would be registered with Sub-registrar- Dollipur under Mouza Trijanga, after



<p>open to sky terrace having a built up area of 614 sq.ft along with 60 car parking space.</p> <p>2. 60 apartments on different floors of Block No-7, of Springville Homes of Surekha Merlin Promoters Pvt Ltd having total super built up area of 59000 sq.ft (built up area of 47200 sq.ft) along with an undivided proportionate share of the land with exclusive right of use for open to sky terrace having a built up area of 614 sq.ft along with 60 car parking space.</p>	<p>Mouza - Trijanga, Odisha. *</p>	<p>completion of necessary formalities</p>
---	------------------------------------	--



(Handwritten signature)



* Details of the land situated at Jajpur, Orissa.

S. No.	Plot No.	Khatiyon No.	Area (Acre)
1.	105/3554	497/1139	1.06
2.	106/3555	497/1140	0.95
3.	107/3556	497/1141	0.67
4.	108	497/1110	0.86
5.	109/3535	497/1120	0.80
6.	107/3058	497/619	0.27
7.	110/2226	497/619	0.36

PART-II

**DESCRIPTION OF THE LEASEHOLD PROPERTY OF THE
AMALGAMATING COMPANY NO. 4 TO BE TRANSFERRED
TO AMALGAMATED COMPANY**

S. No.	Description	Property Location
	NA	



PART-III

SHORT DESCRIPTION OF STOCKS, SHARES, DEBENTURES AND OTHER CHARGES IN ACTION OF THE AMALGAMATING COMPANY NO. 4 TO BE TRANSFERRED TO AMALGAMATED COMPANY

INVESTMENTS TO BE TRANSFERRED TO AMALGAMATED COMPANY

I. Mutual Funds:

Sr. No.	Folio No.	Name of Mutual Funds	No. of Units
1.	Nil		

II. Bonds

Sr. No.	Folio No./ DP ID – Client ID	Name of Bonds	No. of Bonds
1.	Nil		

III. Shares

Sr. No.	Particulars	No. of Shares
1.	NIL	

186
2023



ATTESTED
B. Singh
NOTARY PUBLIC
DELHI (INDIA)



- 9 FEB 2023

ANNEXURE – A

SCHEDULE OF ASSETS OF
JSL LIFESTYLE LIMITED (AMALGAMATING COMPANY
NO. 2) TO BE TRANSFERRED TO JINDAL STAINLESS
LIMITED ("AMALGAMATED COMPANY")

PART-I

DESCRIPTION OF THE FREEHOLD PROPERTY OF THE
AMALGAMATING COMPANY NO. 2 TO BE TRANSFERRED
TO AMALGAMATED COMPANY

Title Document	Property Location	Authority where registered
Pathredi Plant	39/11, 19/2, 21, 40/15/2 7 Milestone, Tauru Road, Pathredi, Gurgaon, Haryana	Tehsil – Manesar District – Gurgaon, Haryana



8

PART-II**DESCRIPTION OF THE LEASEHOLD PROPERTY OF THE
AMALGAMATING COMPANY NO. 2 TO BE TRANSFERRED
TO AMALGAMATED COMPANY**

S. No.	Description	Property Location
1.	MG Store	Basement and Ground Floor 296/2 Min west, Revenue Estate, Village Sultanpur, Near Sultanpur Metro Station, New Delhi
2.	Chennai plant 1	D-2, CMDA Industrial Estate, Maraimalainagar, Chennai, State - Tamil Nadu, PIN- 603209
3.	Chennai plant 2	E-8/2 CMDA Industrial Estate, Maraimalainagar, Chennai, State - Tamil Nadu, PIN- 603209
4.	Corporate Office	Plot No. 50, Sector 32, Gurugram - 122001 (Seats on 5 th and 6 th Floor).
5.	Defence Colony	B-77, Defence Colony, New Delhi, 110024

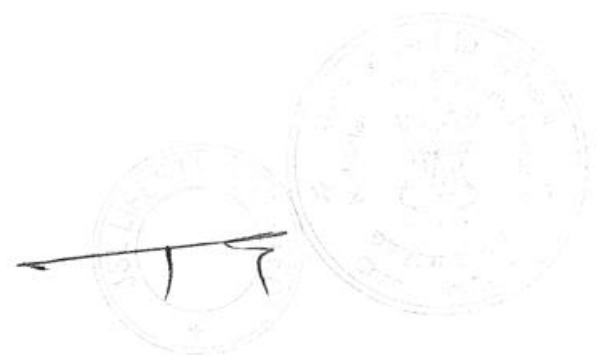

6.	Defence Colony	G-4/1515, Wazir Nagar, Kotla Mubarakpur, New Delhi-110003 (Upto July 2022)
7.	Khan Market	Shop No. 2 A, Ground Floor, Khan Market, New Delhi 110003 bearing Carpet Area is 500 sq. ft. approx. Owner/Lessor – Mr. Vipin Malhotra (Pan No. AAJPM9123H) S/o Late Mr. Shiv Narain Malhotra, R/o F-2/33, F 2, DLF Phase 1, Chakarpur, Gurgaon, Haryana 122002.

PART-III

SHORT DESCRIPTION OF STOCKS, SHARES, DEBENTURES AND OTHER CHARGES IN ACTION OF THE AMALGAMATING COMPANY NO. 2 TO BE TRANSFERRED TO AMALGAMATED COMPANY

INVESTMENTS TO BE TRANSFERRED TO AMALGAMATED COMPANY

I. Mutual Funds:

Sr. No.	Folio No.	Name of Mutual Funds	No. of Units
1.	Nil		



II. Bonds

Sr. No.	Folio No./ DP ID – Client ID	Name of Bonds	No. of Bonds
1.	Nil		

III. Shares

Sr. No.	Particulars	No. of Shares
1.	Green Delhi BQS Limited	23000
2.	Jindal Lifestyle Limited	10000

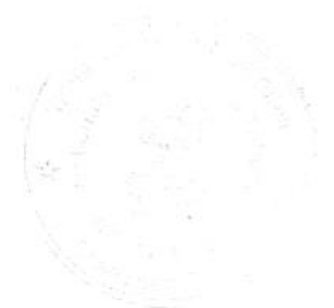

SCHEDULE OF ASSETS OF

JSL LIFESTYLE LIMITED (AMALGAMATING COMPANY NO. 2) TO BE TRANSFERRED TO JINDAL LIFESTYLE LIMITED ("RESULTING COMPANY")

PART-I

DESCRIPTION OF THE FREEHOLD PROPERTY OF THE AMALGAMATING COMPANY NO. 2 TO BE TRANSFERRED TO JINDAL LIFESTYLE LIMITED ("RESULTING COMPANY")

Title Document	Property Location	Authority where registered
Rohad Plant	48 KM Milestone, Rohtak Bypass road, Adjacent to Toll Plaza, Village Rohad Dist., Jhajjar, Haryana	Tehsil - Bahadurgarh District - Jhajjar Haryana

PART-II

DESCRIPTION OF THE LEASEHOLD PROPERTY OF THE AMALGAMATING COMPANY NO. 2 TO BE TRANSFERRED TO JINDAL LIFESTYLE LIMITED ("RESULTING COMPANY")

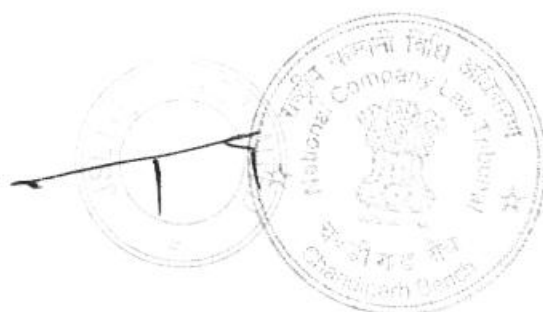

S. No.	Description	Property Location
1.	Nil	

PART-III

SHORT DESCRIPTION OF STOCKS, SHARES, DEBENTURES AND OTHER CHARGES IN ACTION OF THE AMALGAMATING COMPANY NO. 2 TO BE TRANSFERRED TO JINDAL LIFESTYLE LIMITED ("RESULTING COMPANY")

TRADEMARKS TO BE TRANSFERRED TO THE RESULTING COMPANY:

S. No.	Registration/ Application No.	Date	Description of Intellectual Property - Class	Trade marks	Status	Valid Upto
1.	1967475	18/05/2010	8- Hand tools and implements (hand-operated); cutlery; side arms; razors		Registered	18/05/2030
2.	1967476	18/05/2010	20- Furniture, mirrors, picture frames; goods(not included in other classes) of wood, cork, reed, cane, wicker, horn, bone, ivory, whalebone, shell, amber, mother- of-pearl, meerschaum and substitutes for all these materials, or of plastics		Registered	18/05/2030
3.	1967477	18/05/2010	21- Household or kitchen utensils and containers(not of precious metal or		Registered	18/05/2030

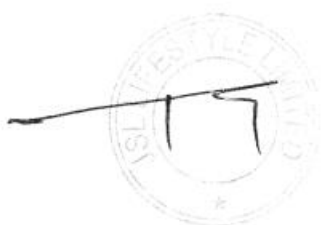

S. No.	Registration/ Application No.	Date	Description of Intellectual Property - Class	Trade marks	Status	Valid Upto
			coated therewith); combs and sponges; brushes(except paints brushes); brush making materials; articles for cleaning purposes; steelwool; unworked or semi-worked glass (except glass used in building); glassware, porcelain and earthenware not included in other classes			
4.	1967478	18/05/2010	27- Carpets, rugs, mats and matting, linoleum and other materials for covering existing floors; wall hangings(non-textile)		Registered	18/05/2030
5.	1967479	18/05/2010	35- Advertising, business management, business administration, office functions.		Registered	18/05/2030
6.	1995293	19/07/2010	20- Furniture, mirrors, picture frames; goods(not included in other classes) of wood, cork, reed, cane, wicker, horn, bone, ivory, whalebone, shell, amber, mother- of-pearl, meerschaum and substitutes for all		Registered	19/07/2020, renewal overdue

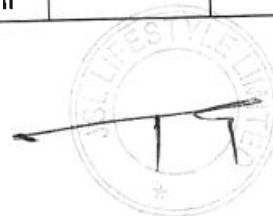

S. No.	Registration/ Application No.	Date	Description of Intellectual Property - Class	Trade marks	Status	Valid Upto
			these materials, or of plastics			
7.	1995294	19/07/2010	11- Apparatus for lighting, heating, steam generating, cooking, refrigerating, drying ventilating, water supply and sanitary purposes		Registered	19/07/2020, renewal overdue
8.	1995295	19/07/2010	14- Precious metals and their alloys and goods in precious metals or coated therewith, not included in other classes; jewellery, precious stones; horological and other chronometric instruments		Registered	19/07/2020, renewal overdue
9.	1995296	19/07/2010	6- Common metals and their alloys; metal building materials;		Registered	19/07/2020, renewal overdue
10.	1995297	19/07/2010	24- Textiles and textile goods, not included in other classes; bed and table covers		Registered	19/07/2020, renewal overdue
11.	1995299	19/07/2010	18- Leather and imitations of leather, and goods made of these materials and not included in other classes; animal skins, hides, trunks and travelling bags; umbrellas, parasols and walking sticks; whips, harness and saddlery		Registered	19/07/2020, renewal overdue



S. No.	Registration/ Application No.	Date	Description of Intellectual Property - Class	Trade marks	Status	Valid Upto
12.	1995300	19/07/2010	16- Paper, cardboard and goods made from these materials, not included in other classes; printed matter; bookbinding material; photographs; stationery; adhesives for stationery or household purposes; artists' materials; paint brushes; typewriters and office requisites (except furniture); instructional and teaching material (except apparatus); plastic materials for packaging (not included in other classes); playing cards; printers' type; printing blocks		Registered	19/07/2020, renewal overdue
13.	1995302	19/07/2010	35- Advertising, business management, business administration, office functions.		Registered	19/07/2020, renewal overdue
14.	1995303	19/07/2010	27- Carpets, rugs, mats and matting, linoleum and other materials for covering existing floors; wall hangings(non-textile)		Registered	19/07/2020, renewal overdue



S. No.	Registration/ Application No.	Date	Description of Intellectual Property - Class	Trade marks	Status	Valid Upto
15.	1995304	19/07/2010	28- Games and playthings, gymnastic and sporting articles not included in other classes; decorations for Christmas trees		Registered	19/07/2020, renewal overdue
16.	1995306	19/07/2010	25- Clothing, footwear, headgear		Registered	19/07/2020, renewal overdue
17.	2314636	12/04/2012	6- Common metals and their alloys; metal building materials;		Registered	12/04/2022
18.	2314638	12/04/2012	20- Furniture, mirrors, picture frames; goods(not included in other classes) of wood, cork, reed, cane, wicker, horn, bone, ivory, whalebone, shell, amber, mother- of-pearl, meerschaum and substitutes for all these materials, or of plastics		Registered	12/04/2022
19.	2314640	12/04/2012	35- Advertising, business management, business administration, office functions.		Registered	12/04/2022
20.	2235154	17/11/2011	6- Common metals and their alloys; metal building materials		Registered	17/11/2021



S. No.	Registration/ Application No.	Date	Description of Intellectual Property - Class	Trade marks	Status	Valid Upto
21.	2235155	17/11/2011	8- Hand tools and implements (hand-operated); cutlery; side arms; razors	Krom	Registered	17/11/2021
22.	2235157	17/11/2011	14- Precious metals and their alloys and goods in precious metals or coated therewith, not included in other classes; jewellery, precious stones; horological and other chronometric instruments	Krom	Registered	17/11/2021
23.	2235158	17/11/2011	16- Paper, cardboard and goods made from these materials, not included in other classes; printed matter; bookbinding material; photographs; stationery; adhesives for stationery or household purposes; artists' materials; paint brushes; typewriters and office requisites (except furniture); instructional and teaching material (except apparatus); plastic materials for packaging (not included in other classes); playing cards; printers' type; printing blocks	Krom	Registered	17/11/2021

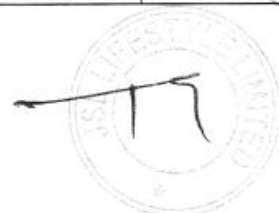

S. No.	Registration/ Application No.	Date	Description of Intellectual Property - Class	Trade marks	Status	Valid Upto
24.	2235159	17/11/2011	18- Leather and imitations of leather, and goods made of these materials and not included in other classes; animal skins, hides, trunks and travelling bags; umbrellas, parasols and walking sticks; whips, harness and saddler		Registered	17/11/2021
25.	2235161	17/11/2011	21- Household or kitchen utensils and containers(not of precious metal or coated therewith); combs and sponges; brushes(except paints brushes); brush making materials; articles for cleaning purposes; steelwool; unworked or semi-worked glass (except glass used in building); glassware, porcelain and earthenware not included in other classes		Registered	17/11/2021
26.	2235162	17/11/2011	24- Textiles and textile goods, not included in other classes; bed and table covers.		Registered	17/11/2021
27.	2235163	17/11/2011	25- Clothing, footwear, headgear		Registered	17/11/2021
28.	2235165	17/11/2011	27 Carpets, rugs, mats and matting, linoleum and other		Registered	17/11/2021



S. No.	Registration/ Application No.	Date	Description of Intellectual Property - Class	Trade marks	Status	Valid Upto
			materials for covering existing floors; wall hangings(non-textile)			
29.	3708159	21/12/2017	11- Apparatus for lighting, heating, steam generating, cooking, refrigerating, drying ventilating, water supply and sanitary purposes	alc	Objected	
30.	3708160	21/12/2017	19- Furniture, mirrors, picture frames; goods(not included in other classes) of wood, cork, reed, cane, wicker, horn, bone, ivory, whalebone, shell, amber, mother- of-pearl, meerschaum and substitutes for all these materials, or of plastics	alc	Objected	
31.	3708161	21/12/2017	20- Furniture, mirrors, picture frames; goods(not included in other classes) of wood, cork, reed, cane, wicker, horn, bone, ivory, whalebone, shell, amber, mother- of-pearl, meerschaum and substitutes for all these materials, or of plastics	alc	Registered	21/12/2027



S. No.	Registration/ Application No.	Date	Description of Intellectual Property - Class	Trade marks	Status	Valid Upto
32.	3708162	21/12/2017	37- Building construction; repair; installation services.	ALC	Accepted	
33.	3708163	21/12/2017	11- Apparatus for lighting, heating, steam generating, cooking, refrigerating, drying ventilating, water supply and sanitary purposes	ALC	Registered	21/12/2027
34.	3708164	21/12/2017	19- Building materials, (non-metallic), non-metallic rigid pipes for building; asphalt, pitch and bitumen; non-metallic transportable buildings; monuments, not of metal.	ALC	Registered	21/12/2027
35.	3708165	21/12/2017	20- Furniture, mirrors, picture frames; goods(not included in other classes) of wood, cork, reed, cane, wicker, horn, bone, ivory, whalebone, shell, amber, mother- of-pearl, meerschaum and substitutes for all these materials, or of plastics	ALC	Registered	21/12/2027
36.	3708166	21/12/2017	37- Building construction; repair; installation services.		Registered	21/12/2027



S. No.	Registration/ Application No.	Date	Description of Intellectual Property - Class	Trade marks	Status	Valid Upto
37.	4339651	06/11/2019	14- Precious metals and their alloys and goods in precious metals or coated therewith, not included in other classes; jewellery, precious stones; horological and other chronometric instruments	DEVICE	Opposed	We are contesting the same
38.	4339652	06/11/2019	20- Furniture, mirrors, picture frames; goods(not included in other classes) of wood, cork, reed, cane, wicker, horn, bone, ivory, whalebone, shell, amber, mother- of-pearl, meerschaum and substitutes for all these materials, or of plastics	Device	Objected	
39.	4339653	06/11/2019	21 - Household or kitchen utensils and containers(not of precious metal or coated therewith); combs and sponges; brushes(except paints brushes); brush making materials; articles for cleaning purposes; steelwool; unworked or semi-worked glass (except glass used in building); glassware, porcelain and earthenware not	Device	Opposed	We are contesting the same



22

S. No.	Registration/ Application No.	Date	Description of Intellectual Property - Class	Trade marks	Status	Valid Upto
			included in other classes			
40.	4339654	06/11/2019	27- Carpets, rugs, mats and matting, linoleum and other materials for covering existing floors; wall hangings(non-textile)	Device	Objected	
41.	4339655	06/11/2019	35- Advertising, business management, business administration, office functions.	Device	Registered	06/11/2029
42.	5294037	21/01/2022	6-common metals and their alloys; metal building materials; transportable buildings of metal; materials of metal for railway tracks; non-electric cables and wires of common metal; ironmongery, small items of metal hardware; pipes and tubes of metal; safes; goods of common metal not included in other classes; ores.	JINDAL ARC-Device	Marked for Exam	
43.	5294038	21/01/2022	8- hand tools and implements (hand-operated); cutlery; side arms; razors	JINDAL ARC-Device	Marked for Exam	
44.	5294039	21/01/2022	9- scientific, nautical, surveying,	JINDAL ARC-Device	Marked for Exam	

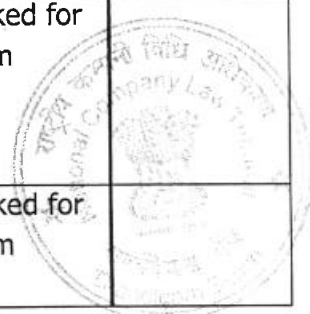

S. No.	Registration/ Application No.	Date	Description of Intellectual Property - Class	Trade marks	Status	Valid Upto
			photographic, cinematographic, optical, weighing, measuring, signalling, checking (supervision), life-saving and teaching apparatus and instruments; apparatus and instruments for conducting, switching, transforming, accumulating, regulating or controlling electricity; apparatus for recording, transmission or reproduction of sound or images; magnetic data carriers, recording discs; automatic vending machines and mechanisms for coin-operated apparatus; cash registers, calculating machines, data processing equipment and computers; fire-extinguishing apparatus.			
45.	5294040	21/01/2022	10- surgical, medical, dental and veterinary apparatus and instruments, artificial limbs, eyes and teeth;	JINDAL ARC-Device	Marked for Exam	

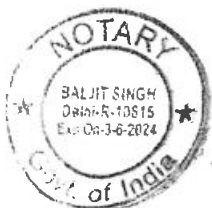

S. No.	Registration/ Application No.	Date	Description of Intellectual Property - Class	Trade marks	Status	Valid Upto
			orthopedic articles; suture materials			
46.	5294041	21/01/2022	11- apparatus for lighting, heating, steam generating, cooking, refrigerating, drying, ventilating, water supply and sanitary purposes.	JINDAL ARC-Device	Marked for Exam	
47.	5294042	21/01/2022	20- furniture, mirrors, picture frames; goods (not included in other classes) of wood, cork, reed, cane, wicker, horn, bone, ivory, whalebone, shell, amber, mother-of-pearl, meerschaum and substitutes for all these materials, or of plastics.	JINDAL ARC-Device	Marked for Exam	
48.	5294043	21/01/2022	21- household or kitchen utensils and containers (not of precious metal or coated therewith); combs and sponges; brushes (except paint brushes); brush-making materials; articles for cleaning purposes; steelwool; unworked or semi-worked glass (except glass used in building); glassware, porcelain and earthenware not	JINDAL ARC-Device	Marked for Exam	



S. No.	Registration/ Application No.	Date	Description of Intellectual Property - Class	Trade marks	Status	Valid Upto
			included in other classes			
49.	5294044	21/01/2022	35- advertising; business management; business administration; office functions	JINDAL ARC-Device	Marked for Exam	
50.	5294046	21/01/2022	40- treatment of materials.	JINDAL ARC-Device	Marked for Exam	
51.	5294047	21/01/2022	42- research and designing, product designing, architectural designing	JINDAL ARC-Device	Marked for Exam	



ATTESTED
B. Singh
NOTARY PUBLIC
DELHI (INDIA)

18/2
2023

9 FEB 2023



2
7

ANNEXURE – A

SCHEDULE OF ASSETS OF

JSL MEDIA LIMITED ("AMALGAMATING COMPANY NO. 3") TO BE TRANSFERRED TO JINDAL STAINLESS LIMITED ("AMALGAMATED COMPANY")

PART-I

DESCRIPTION OF THE FREEHOLD PROPERTY OF THE AMALGAMATING COMPANY NO. 3 TO BE TRANSFERRED TO AMALGAMATED COMPANY

Title Document	Property Location	Authority where registered
NA		

PART-II

DESCRIPTION OF THE LEASEHOLD PROPERTY OF THE AMALGAMATING COMPANY NO. 3 TO BE TRANSFERRED TO AMALGAMATED COMPANY

S. No.	Description	Property Location
1.	NA	



8

PART-III

**SHORT DESCRIPTION OF STOCKS, SHARES,
DEBENTURES AND OTHER CHARGES IN ACTION OF THE
AMALGAMATING COMPANY NO. 3 TO BE TRANSFERRED
TO AMALGAMATED COMPANY**

**INVESTMENTS TO BE TRANSFERRED TO AMALGAMATED
COMPANY**

I. Mutual Funds:

Sr. No.	Folio No.	Name of Mutual Funds	No. of Units
1.	Nil		

II. Bonds

Sr. No.	Folio No./ DP ID – Client ID	Name of Bonds	No. of Bonds
1.	Nil		

III. Shares

Sr. No.	Particulars	No. of Shares
1.	Green Delhi BQS Limited	26000



184
2023

ATTESTED
B. Singh
NOTARY PUBLIC
DELHI (INDIA)
9 FEB 2023



291
36

ANNEXURE A

SCHEDULE OF ASSETS

OF

JINDAL STAINLESS (HISAR) LIMITED ("AMALGAMATING COMPANY NO. 1") TO BE TRANSFERRED TO JINDAL STAINLESS LIMITED ("AMALGAMATED COMPANY")

PART - I

**DESCRIPTION OF THE FREEHOLD PROPERTY OF THE
AMALGAMATING COMPANY NO. 1**

- I. All that pieces or parcel of land admeasuring 2942 Kanals and 14 Marlas situated in various villages in the district of Hisar, in the state of Haryana together with all buildings and structures thereon and all plant and machinery attached to the earth or permanently fastened to anything attached to the earth.

Sr. No.	Location	Khasra No.	Area (Kanal-Marla)
1.	Satrod Khurd, Hisar	194//3/2 min	01-02
2.	Satrod Khurd, Hisar	181//14/1/2 min, 181//14/1/3 min, 181//7/1 min, 181//4/2 min, 159//24/2, 159//24/3, 181//13/2 min, 181//18/1, 181//23/2, 195//3/2	03-10
3.	Satrod Khurd, Hisar	145//11, 145//20, 145//21, 146//13, 146//14, 146//15, 146//16, 146//17, 146//18, 146//19, 146//20, 146//22	88-02
4.	Satrod Khurd,	145//19, 145//22, 161//2, 161//1/2	27-14

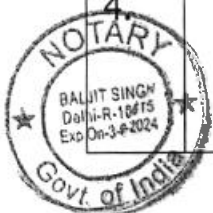

	Hisar		
5.	Satrod Khurd, Hisar	159//2/1, 159//3/1, 159//4/1/1	03-05
6.	Satrod Khurd, Hisar	167//4	02-17
7.	Satrod Khurd, Hisar	167//4	01-12
8.	Satrod Khurd, Hisar	139//24, 139//23/2, 167//4	12-11
9.	Satrod Khurd, Hisar	146//21, 146//22 min, 147//16	21-16
10.	Satrod Khurd, Hisar	147//25	07-04
11.	Satrod Khurd, Hisar	159//12/1	01-02
12.	Satrod Khurd, Hisar	161//1/1, 146//23, 160//5/2, 146//24, 146//25	32-12
13.	Satrod Khurd, Hisar	147//23/1	03-14

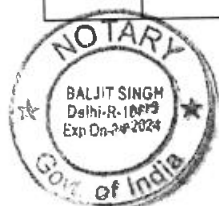

14.	Satrod Khurd, Hisar	147//23/2	03-14
15.	Satrod Khurd, Hisar	147//18, 147//19/1/2, 147//22, 147//23/2, 147//19/1/1	24-17
16.	Satrod Khas, Hisar	148//4/2, 148//5/1	06-00
17.	Satrod Khas, Hisar	148//3/1, 148//4/1	06-00
18.	Satrod Khas, Hisar	93//16/2, 93//17/2/2, 93//18/2/2, 93//23, 93//24, 93//25, 117//1/1, 118//5	34-06
19.	Satrod Khas, Hisar	94//9/1, 94//10, 94//11/1/1, 94//12/1, 94//20/2/2, 94//21/1/2	25-13
20.	Satrod Khas, Hisar	91//21, 91//22, 91//23, 91//24/1, 92//25, 93//5/2, 94//1, 94//2, 94//3, 94//4/1	66-10
21.	Satrod Khas, Hisar	94//13/2/1, 94//14/1	1-19
22.	Satrod Khas, Hisar	94//4/2, 94//8/1, 94//7, 91//24/2	23-08
23.	Satrod Khas, Hisar	167//2/2/2, 167//3/1(5/9 th part)	03-29



24.	Satrod Khas, Hisar	139//23/1, 167//3/1(4/9 th part), 167//7/1, 167//7/2/1	13-21
25.	Satrod Khas, Hisar	139//14, 139//17, 139//18	12-00
26.	Satrod Khas, Hisar	139//14, 139//17, 139//18	12-00
27.	Satrod Khas, Hisar	139//12/2min, 139//13/2	04-00
28.	Satrod Khas, Hisar	91//10/2, 91//11, 91//12/2, 91//19, 91//20, 92//6, 92//7/1, 92//14, 92//15, 92//16, 92//17, 92//18, 92//19, 92//20, 92//21, 92//22, 92//23, 92//24, 93//1, 93//2, 93//3	133-04
29.	Satrod Khas, Hisar	92//7/2/2, 92//8, 92//9, 92//12, 92//13	29-00
30.	Satrod Khas, Hisar	139//4	07-07
31.	Satrod Khas, Hisar	139//7	08-00
32.	Satrod Khas, Hisar	147//10/2, 147//11, 148//6/2/1, 148//15/2, 147//9/3, 147//12/1	28-01
33.	Satrod Khas, Hisar	148//6/2/2, 148//7/2, 148//8/2, 148//14, 148//15/1	28-00



34.	Satrod Khas, Hisar	147//1, 147//2, 147//3, 147//8, 147//9/1, 147//9/2, 147//10/1, 147//12/2, 147//13, 148//6/1, 148//7/1, 148//8/1	27-13
35.	Satrod Khas, Hisar	147//1, 147//2, 147//3, 147//8, 147//9/1, 147//9/2, 147//10/1, 147//12/2, 147//13, 148//6/1, 148//7/1, 148//8/1	27-13
36.	Satrod Khas, Hisar	93//9, 93//12/1/2	09-08
37.	Satrod Khas, Hisar	224//9, 224//10, 224//11, 224//12, 224//21, 212//21, 212//22, 224//1, 224//2, 225//1, 225//9, 225//10, 225//12/1, 224//20, 223//5/2, 225//11, 225//12/2, 225//19/1	97-00
38.	Satrod Khas, Hisar	140//21/2/2, 140//22, 165//6/1/1, 166//1/2, 166//2, 166//9/1, 166//10, 165//6/1/2	36-17
39.	Satrod Khas, Hisar	194//6, 194//15, 194//16, 194//17, 194//24/2 min, 194//25 min, 213//4	45-18
40.	Satrod Khas, Hisar	165//15/2, 166//11, 166//12, 166//20/1, 166//9/2	30-04
41.	Satrod Khas, Hisar	66//11/2, 66//18, 66//19/2, 66//20/2, 66//22/2, 66//23/2, 92//3/2, 92//4/1/2, 66//2/1/2, 67//20, 67//21, 67//22, 67//23, 91//1, 91//2, 91//3, 91//9/1, 91//10/1, 92//5/2	104-13
42.	Satrod Khas, Hisar	66//19/1, 66//20/1, 66//22/1, 66//23/1, 92//3/1, 92//4/1/1	02-05
43.	Satrod Khas, Hisar	93//14/2/2, 93//15/2, 93//16/1, 93//17/1/1, 93//17/2/1, 93//18/1/2, 93//18/2/1, 93//19/2, 94//11/1/2, 94//20/2/1, 94//21/1/1, 329//2/1	20-02

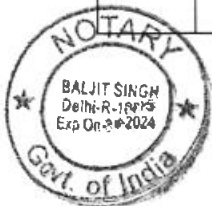

44.	Satrod Khas, Hisar	93//4, 93//7, 93//8, 93//13, 93//14/1, 93//14/2/1, 93//17/1/2, 93//18/1/1, 93//6/1, 93//15/1/2, 93//5/1, 93//6/2, 93//15/1/1	60-03
45.	Mirka, Hisar	• 31//25/2, 32//19/2, 32//21/1, 32//21/2, 32//22, 32//23, 40//5/2, 40//6, 40//14/2, 40//15, 40//17, 40//18, 40//24, 40//25, 39//1, 39//2, 39//3, 39//8, 39//9, 39//10, 39//11, 39//12, 39//13/1, 39//19, 39//20, 39//21, 39//22, 40//16, 32//20, 31//16/1, 39//17/2, 39//24/1, 39//14/1/1, 39//14/2/2, 39//13/2, 39//17/1, 39//18, 39//23, 39//4/1, 39//7/2	249-18
46.	Mirka, Hisar	40//3/2, 40//4, 40//5/1	11-07
47.	Mirka, Hisar	31//24min, 31//25/1	12-06
48.	Mirka, Hisar	39//15, 39//6/2	15-11
49.	Mirka, Hisar	39//4/2, 39//7/1, 39//14/1/2, 39//14/2/1	12-01
50.	Satrod Khurd, Hisar	145//10, 146//6, 146//7, 146//8, 146//9, 146//10, 146//11, 146//12, 147//15/2, 147//17, 147//24/1, 147//24/2	80-17
51.	Satrod Khurd, Hisar	147//6, 147//7, 147//14, 147//15/1	29-10
52.	Satrod Khurd, Hisar	124//3	02-11
53.	Satrod Kalan, Hisar	179//11/1, 180//13/2, 180//14, 180//15, 179//10, 179//20, 180//6, 180//7	48-12

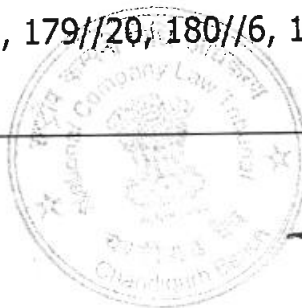

54.	Satrod Khurd, Hisar	146//1, 146//3, 146//3/2	15-20
55.	Satrod Khurd, Hisar	146//2	08-00
56.	Satrod Khurd, Hisar	116//21, 123//16/1, 123//16/2 124//1, 124//2, 124//20, 124//21, 124//22, 124//8/2, 124//18, 124//19, 124//23, 124//9, 124//12, 124//13, 124//10, 124//11 and Khasra Numbers 123//23, 123//24, 123//25, 146//3/2, 147//4 and 147//5	145-24
57.	Satrod Khurd, Hisar	117//10(2/9), 117//11(8-0), 117//12(6-2), 117//18(9-9), 117//19, 117//20(8-0), 117//21(8-0), 117//22(8-0), 117//23(8-0), 118//7(6-4), 118//6(4-11), 118//13(8-0), 118//14(8-0), 118//15, 118//15/2, 118//16(8- 0), 118//17(8-0), 118//18(8-0), 118//23(8-0), 118//24(8-0), 118//25(8-0), 122//3/1(5-7), 118//8(8-0), 123//1(8-0), 123//2 min East(3- 12), 122//4(7-11), 122//5(7-11), 123//2-min East (4-8)	193-4

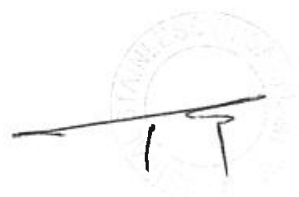
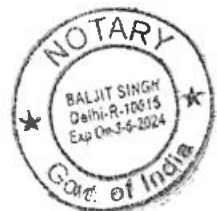
58.	Satrod Khurd, Hisar	122//3/2, 122//8/2, 122//13, 122//17, 122//18, 122//23/1, 123//17, 123//15, 123//16, 123//6/2, 339//1, 983/1, 984, 985, 123//10, 123//11, 123//12, 123//18, 123//19, 123//20, 123//21, 123//22, 123//2(5-19), 122//6, 122//7, 122//8/1, 122//14, 122//15/1, 122//15/2, 122//16, 122//23/2 (4-0), 122//25, 122//24, 123//13, 123//14, 123//3, 123//4, 123//8, 123//5/1, 123//5/2 (7-14), 123//6/1, 123//7, 123//9, 117//24, 117//25, , 117//17, 292//2 min	282-00
59.	Satrod Khas, Hisar	176//1, 176//10, 176/11, 176//20/1, 176//20/2, 177//1, 177//2, 177//3, 177//4, 177//5/1, 177//6/2, 177//7, 177//8, 177//9, 177//10, 177//11, 177//12, 177//13, 177//14, 177//15/1, 177//16/2, 177//17/1, 177//18/1, 177//19/1, 177//20/1, 178//4/2, 178//5, 178//06/2, 178//15/2, 178//16/1/2	205-10
60.	Satrod Khas, Hisar	339//1	01-07
61.	Satrod Khas, Hisar	177//5/2, 177//6/1, 177//15/2, 177//16/1, 177//16/3, 177//17/2, 177//18/2, 177//19/2, 177//20/2, 178//16/2, 178//17/3	01-10
62.	Satrod Khas, Hisar	145//14/2, 145//15, 144//11, 144//20/1, 145//13/2, 145//14/1, 145//8, 145//9, 145//12, 145//13/1	55-15
63.	Satrod Khas, Hisar	66//9, 66//12, 66//11/1, 66//11/2, 66//10	28-14

13



64.	Satrod Khas, Hisar	66//16/2, 66//17, 92//4/2	21-8
65.	Satrod Khas, Hisar	116//18/2, 116//19, 116//20/1, 116//22, 116//23/1	24-4
66.	Satrod Khas, Hisar	66//16/1, 66//24/1, 66//24/2, 66//25, 92//5/1	24-10
67.	Satrod Khas, Hisar	145//1, 145//2, 145//3, 146//4/2, 146//5, 146//4/1, 124//25/2, 125//21, 125//22/1	53-14
68.	Satrod Khas, Hisar	124//7, 124//8/1, 124//14, 124//15, 124//16, 124//17, 124//24, 124//25/1	58-5
69.	Satrod Khas, Hisar	219//16/2, 219//17, 219//18, 219//19, 219//20, 219//22, 219//23, 219//24, 219//25, 220//21, 231//3, 231//4/1	85-1
70.	Satrod Khas, Hisar	125//20(8-0), 125//11(4-18), 125//18(3-13), 125//19(8-4), 125//22/2 (4-8), 125//23 (8-0)	37-03
71.	Satrod Khas, Hisar	67//12/2 (4-18), 67//19 (8-0), 91//8/2 (4-0), 91//9/2 (4-4), 91//12/1(5-1), 91//13/1 (3-8), 91//18/2 (3-13), 67//18/3 min Paschim (3-12)	36-16
72.	Satrod Khurd, Hisar	125//24 (7-0), 125//25 (2-7), 144//10/2 (5-3), 145//4 (8-0), 145//5 (8-0), 145//6 (8-0), 145// 7 (8-0)	46-10
73.	Satrod Khurd, Hisar	144//20/2 (4-10), 145//16 (8-0), 145//17 (8- 0), 145//18 (8-0), 145//23/1(6-8)	34-18

II. All that free hold land area admeasuring 4050 Sq Meters, situated at



15

Institutional Plot No. 50-P, Sector -32, in District Gurugram in the State of Haryana, together with all buildings, erections and constructions of every description which are standing, erected or attached or shall at any time hereafter during the continuance of the security hereby constituted, be erected or attached and standing or attached thereto.

Sr. No.	Location	Date & Registration No.	Plot No.	Area (Sq Meters)
1.	Sector – 32, District Gurugram, Haryana	25.09.2008/ Registered on 16.10.2008/ Document No. 16357, book no. 1 in Volume No. 9,753 at Page No. 140	50-P	4050

PART - II

DESCRIPTION OF THE LEASEHOLD PROPERTY OF THE

AMALGAMATING COMPANY NO. 1

- I. All Leasehold Property(ies)/interest/title of the Amalgamating Company No. 1 shall be transferred to the Amalgamated Company.

PART - III

**SHORT DESCRIPTION OF STOCKS, SHARES, DEBENTURES AND
OTHER CHARGES IN ACTION OF THE AMALGAMATING COMPANY NO.**

1

- I. All Investments in Mutual Funds, Bonds, Shares and any other investments of the Amalgamating Company No. 1, Movable Assets (whether charged or not) of the Amalgamating Company No. 1, all licenses, approvals and registrations, all intellectual property rights of the Amalgamating Company No. 1 including all

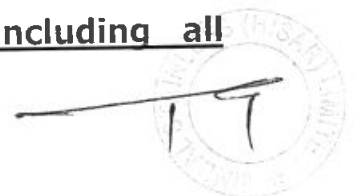
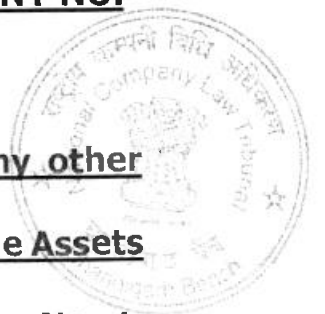

~~17~~ 16

trademarks registration (issued and pending), as on December 31, 2022 shall be transferred to the Amalgamated Company including but not limited to the following:

- a. All movable assets of the Amalgamating Company No. 1 shall be transferred to the Amalgamated Company in accordance with Clause 8.2 of the Scheme;
- b. **Mutual Funds:**

Sr. No.	Folio No.	Name of Mutual Funds	No. of Units
1.	N.A		

c. **Bonds**

Sr. No.	Folio No./ DP ID – Client ID	Name of Bonds	No. of Bonds
1.	N.A		

d. **Shares**

Sr. No.	Particulars	No. of Shares
1.	Jindal Stainless Steelway Limited (wholly owned subsidiary)	1,40,61,667
2.	JSL Lifestyle Limited	2,09,11,676

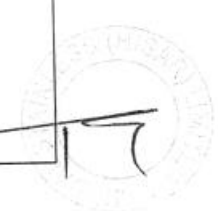
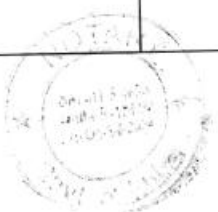

3.	Green Delhi BQS Limited	51,000
4.	JSL Media Limited (wholly owned subsidiary)	50,000
5.	JSL Logistics Limited (wholly owned subsidiary)	50,000
6.	Jindal Strategic Systems Limited	50,000
7.	Jindal Stainless Corporate Management Services Private Limited	5,000
8.	Jindal Stainless Limited	16,82,84,309

17

e. Government/ Semi Government Securities:

Sr. No.	Particulars	Numbers
1.	National Savings Certificate	1500

f. All Licenses, approvals and registrations of the Amalgamating Company 1 shall be transferred to the Amalgamated Company.

g. All Intellectual Property Rights including all copyrights and trademarks registration (including pending applications) shall be transferred to the Amalgamated Company including but not limited







to the following:

18









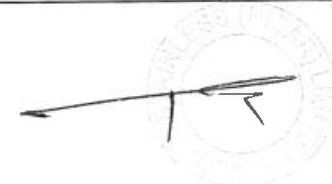
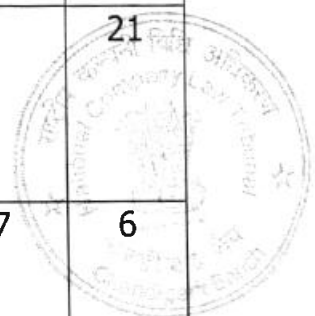

i. DETAILS OF COPYRIGHT

Sr. No.	LABEL	Applicant Name	TM CC No.
1.	JSL JINDAL STAINLESS	JINDAL STAINLESS (HISAR) LIMITED	111829

ii. DETAILS OF TRADEMARKS REGISTRATIONS:







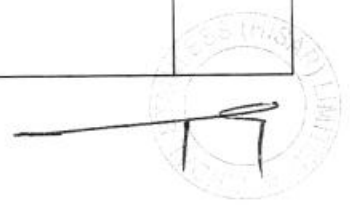



Sr. No.	Trademark	Logo	Application/Registration No.	Class
1.	J-Jindal		747027	6
2.	J-Jindal Stainless		747028	6
3.	J-Jindal Stainless		747029	9
4.	J-Jindal Stainless		747030	10
5.	J-Jindal Stainless		747031	21
6.	JINDAL STAINLESS		1462007	6



7.	JINDAL STAINLESS		1462008	9
8.	JINDAL STAINLESS		1462009	10
9.	JINDAL STAINLESS		1462010	19
10.	JINDAL STAINLESS		1462011	20
11.	JINDAL STAINLESS		1462012	21
12.	JINDAL STAINLESS		1462013	37
13.	JSL STAINLESS STEEL		1746589	4
14.	JSL STAINLESS STEEL		1746590	6
15.	JSL STAINLESS STEEL		1746591	9
16.	JSL STAINLESS STEEL		1746592	10
17.	JSL STAINLESS STEEL		1746593	16







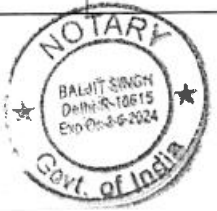



20

18.	JSL STAINLESS STEEL		1746594	19
19.	JSL STAINLESS STEEL		1746595	20
20.	JSL STAINLESS STEEL		1746596	21
21.	JSL STAINLESS STEEL		1746597	35
22.	JSL STAINLESS STEEL		1746598	37
23.	JSL STAINLESS STEEL		1746599	38
24.	JSL STAINLESS STEEL		1746600	39
25.	JSL STAINLESS STEEL (COLOR)		2299902	4
26.	JSL STAINLESS STEEL (COLOR)		2299903	6
27.	JSL STAINLESS STEEL (COLOR)		2299904	9



22 21
16
66

28.	JSL STAINLESS STEEL (COLOR)		2299905	10
29.	JSL STAINLESS STEEL (COLOR)		2299906	16
30.	JSL STAINLESS STEEL (COLOR)		2299907	19
31.	JSL STAINLESS STEEL (COLOR)		2299908	20
32.	JSL STAINLESS STEEL (COLOR)		2299909	21
33.	JSL STAINLESS STEEL (COLOR)		2299910	35
34.	JSL STAINLESS STEEL (COLOR)		2299911	37
35.	JSL STAINLESS STEEL (COLOR)		2299912	38

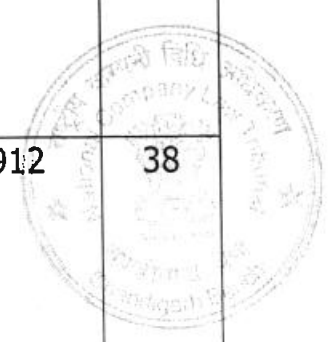





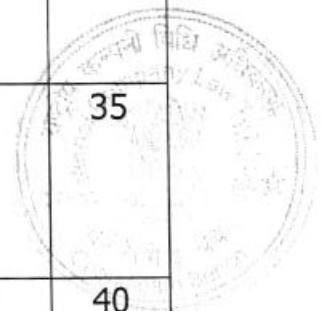

36.	JSL STAINLESS STEEL (COLOR)		2299913	39
37.	KROME	KROME	1736210	6
38.	KROME	KROME	1736211	8
39.	KROME	KROME	1736212	11
40.	KROME	KROME	1736213	14
41.	KROME	KROME	1736214	16
42.	KROME	KROME	1736215	20
43.	KROME	KROME	1736216	21
44.	KROME	KROME	1736217	24
45.	KROME	KROME	1736218	35
46.	KROME	KROME	1736219	40



Handwritten signature or mark.

~~1~~

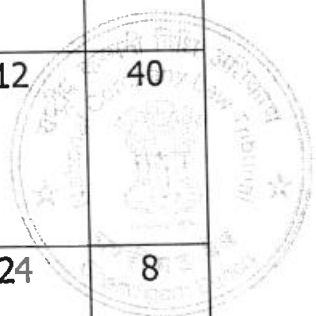









47.	KROME 16+	krome 16+	2531603	6
48.	KROME 16+	krome 16+	2531604	9
49.	KROME 16+	krome 16+	2531605	11
50.	KROME 16+	krome 16+	2531606	14
51.	KROME 16+	krome 16+	2531607	16
52.	KROME 16+	krome 16+	2531608	20
53.	KROME 16+	krome 16+	2531609	21
54.	KROME 16+	krome 16+	2531610	24
55.	KROME 16+	krome 16+	2531611	35
56.	KROME 16+	krome 16+	2531612	40
57.	KROME 16+	krome 16+	2531624	8



58.	KROME 16+	KROME 16+	2531613	6
59.	KROME 16+	KROME 16+	2531614	8
60.	KROME 16+	KROME 16+	2531615	9
61.	KROME 16+	KROME 16+	2531616	11
62.	KROME 16+	KROME 16+	2531617	14
63.	KROME 16+	KROME 16+	2531618	16
64.	KROME 16+	KROME 16+	2531619	20
65.	KROME 16+	KROME 16+	2531620	21
66.	KROME 16+	KROME 16+	2531621	24
67.	KROME 16+	KROME 16+	2531622	35
68.	KROME 16+	KROME 16+	2531623	40



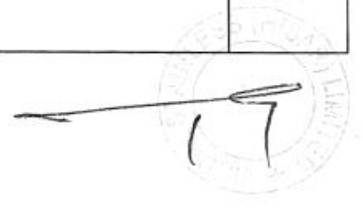
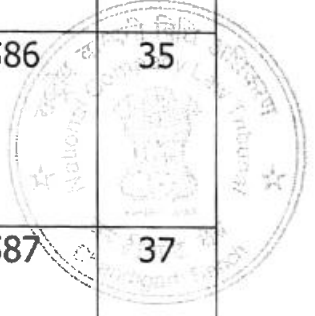

Handwritten signature and date: 17

69.	JINDAL STAINLESS		3161577	4
70.	JINDAL STAINLESS		3161578	6
71.	JINDAL STAINLESS		3161579	9
72.	JINDAL STAINLESS		3161580	10
73.	JINDAL STAINLESS		3161581	11
74.	JINDAL STAINLESS		3161582	16
75.	JINDAL STAINLESS		3161583	19
76.	JINDAL STAINLESS		3161584	20
77.	JINDAL STAINLESS		3161585	21
78.	JINDAL STAINLESS		3161586	35
79.	JINDAL STAINLESS		3161587	37



2023

80.	JINDAL STAINLESS		3161588	38
81.	JINDAL STAINLESS		3161589	39
82.	JINDAL STAINLESS		3161590	40
83.	JINDAL DURASAFE	(WORD)	5259413	6
84.	JINDAL INFINITY	(WORD)	5259412	6

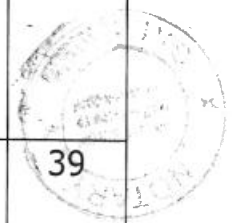

ATTESTED
B. Singh
 NOTARY PUBLIC
 DELHI (INDIA)
 9 FEB 2023

180
 2023



COMPOSITE SCHEME OF ARRANGEMENT

AMONGST

JINDAL STAINLESS LIMITED

(AMALGAMATED COMPANY)

AND

JINDAL STAINLESS (HISAR) LIMITED

(AMALGAMATING COMPANY NO. 1)

AND

JSL LIFESTYLE LIMITED

(DEMERGED COMPANY/AMALGAMATING COMPANY NO. 2)

AND

JSL MEDIA LIMITED

(AMALGAMATING COMPANY NO. 3)

AND

JINDAL STAINLESS CORPORATE MANAGEMENT SERVICES PRIVATE LIMITED

(AMALGAMATING COMPANY NO. 4)

AND

JINDAL LIFESTYLE LIMITED

(RESULTING COMPANY)

AND

THEIR RESPECTIVE SHAREHOLDERS AND CREDITORS

(UNDER SECTIONS 230 TO 232 READ WITH SECTION 66 AND OTHER APPLICABLE SECTIONS OF THE COMPANIES ACT, 2013)

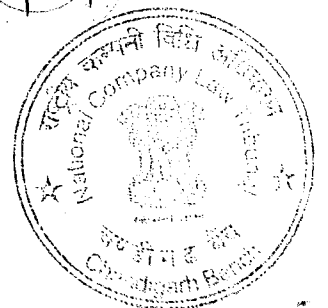
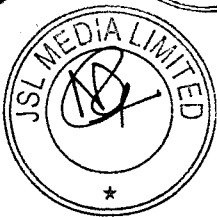
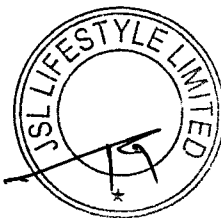
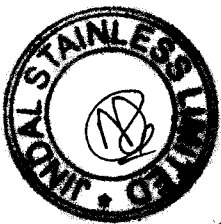
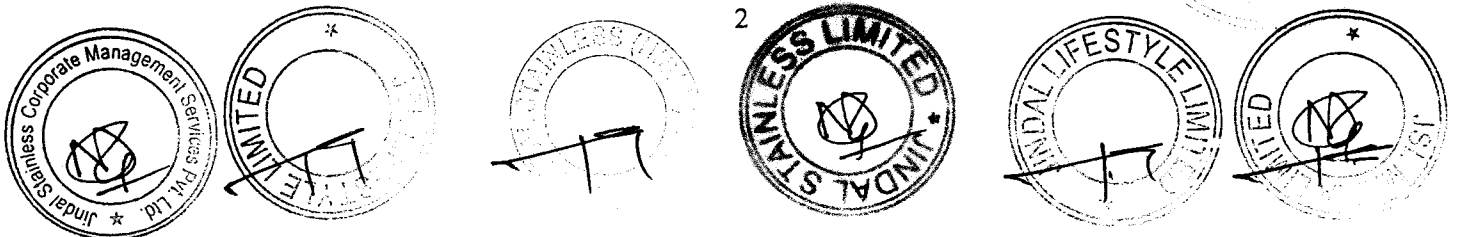

TABLE OF CONTENTS

INTRODUCTION	4
1 PREAMBLE	4
2 BACKGROUND AND DESCRIPTION OF THE PARTIES TO THIS SCHEME	4
3 NEED AND RATIONALE FOR THIS SCHEME.....	5
4 OVERVIEW OF THIS SCHEME.....	7
PART A	8
DEFINITIONS, COMPLIANCE WITH TAX LAWS AND CAPITAL STRUCTURE	8
5 DEFINITIONS.....	8
6 COMPLIANCE WITH TAX LAWS.....	12
7 CAPITAL STRUCTURE	13
PART B.....	16
AMALGAMATION OF AMALGAMATING COMPANY NO. 1 INTO AND WITH THE AMALGAMATED COMPANY.....	16
8 AMALGAMATION OF AMALGAMATING COMPANY NO. 1 INTO AND WITH THE AMALGAMATED COMPANY	16
9 CONDUCT OF AFFAIRS UNTIL THE EFFECTIVE DATE	22
10 TREATMENT OF TAXES	22
11 CONDUCT OF AFFAIRS AFTER THE EFFECTIVE DATE.....	24
12 SAVING OF CONCLUDED TRANSACTIONS	25
13 CHANGE IN AUTHORISED SHARE CAPITAL OF THE AMALGAMATED COMPANY	25
14 AMENDMENT TO OBJECTS OF THE AMALGAMATED COMPANY	25
15 DISCHARGE OF CONSIDERATION	26
16 CANCELLATION OF SHARES	28
17 DISSOLUTION OF AMALGAMATING COMPANY NO. 1	28
18 ACCOUNTING TREATMENT	28
PART C.....	29
DEMERGER OF THE DEMERGED UNDERTAKING AND VESTING OF THE SAME INTO AND WITH THE RESULTING COMPANY	29
19 DEMERGER OF THE DEMERGED UNDERTAKING OF THE DEMERGED COMPANY AND VESTING OF THE SAME WITH THE RESULTING COMPANY	29
20 CONDUCT OF AFFAIRS UNTIL THE EFFECTIVE DATE	36
21 TREATMENT OF TAXES	36
22 CONDUCT OF AFFAIRS AFTER THE EFFECTIVE DATE.....	37
23 SAVING OF CONCLUDED TRANSACTIONS	38
24 DISCHARGE OF CONSIDERATION	38
25 REDUCTION IN SHARE CAPITAL OF THE RESULTING COMPANY	40
26 INCREASE IN THE AUTHORISED SHARE CAPITAL OF THE RESULTING COMPANY	41
27 ACCOUNTING TREATMENT IN THE BOOKS OF THE DEMERGED COMPANY.....	41
28 ACCOUNTING TREATMENT IN THE BOOKS OF RESULTING COMPANY	42
PART D	42
AMALGAMATION OF AMALGAMATING COMPANY NO. 2 INTO AND WITH THE AMALGAMATED COMPANY.....	42
29 AMALGAMATION OF AMALGAMATING COMPANY NO. 2 INTO AND WITH THE AMALGAMATED COMPANY	42
30 CONDUCT OF AFFAIRS UNTIL THE EFFECTIVE DATE	48
31 TREATMENT OF TAXES	49



32 CONDUCT OF AFFAIRS AFTER THE EFFECTIVE DATE.....50

33 SAVING OF CONCLUDED TRANSACTIONS51

34 DISCHARGE OF CONSIDERATION51

35 CHANGE IN AUTHORISED SHARE CAPITAL OF THE AMALGAMATED COMPANY52

36 DISSOLUTION OF AMALGAMATING COMPANY NO. 2.....53

37 ACCOUNTING TREATMENT53

PART E.....54

AMALGAMATION OF AMALGAMATING COMPANY NO. 3 INTO AND WITH THE AMALGAMATED COMPANY.....54

38 AMALGAMATION OF AMALGAMATING COMPANY NO. 3 INTO AND WITH THE AMALGAMATED COMPANY54

39 AMENDMENT TO OBJECTS OF THE AMALGAMATED COMPANY60

40 CONDUCT OF AFFAIRS UNTIL THE EFFECTIVE DATE60

41 TREATMENT OF TAXES62

42 CONDUCT OF AFFAIRS AFTER THE EFFECTIVE DATE.....63

43 SAVING OF CONCLUDED TRANSACTIONS64

44 DISCHARGE OF CONSIDERATION64

45 DISSOLUTION OF AMALGAMATING COMPANY NO. 364

46 ACCOUNTING TREATMENT64

PART F.....65

AMALGAMATION OF AMALGAMATING COMPANY NO. 4 INTO AND WITH THE AMALGAMATED COMPANY.....65

47 AMALGAMATION OF AMALGAMATING COMPANY NO. 4 INTO AND WITH THE AMALGAMATED COMPANY65

48 AMENDMENT TO OBJECTS OF THE AMALGAMATED COMPANY71

49 CONDUCT OF AFFAIRS UNTIL THE EFFECTIVE DATE72

50 TREATMENT OF TAXES72

51 CONDUCT OF AFFAIRS AFTER THE EFFECTIVE DATE.....74

52 SAVING OF CONCLUDED TRANSACTIONS74

53 DISCHARGE OF CONSIDERATION75

54 DISSOLUTION OF AMALGAMATING COMPANY NO. 4.....75

55 ACCOUNTING TREATMENT75

PART G76

GENERAL TERMS AND CONDITIONS.....76

56 CONDITIONALITY OF THE SCHEME76

57 EFFECTIVENESS OF THE SCHEME.....76

58 APPLICATIONS TO THE COURT.....77

59 MODIFICATIONS/AMENDMENTS TO THE SCHEME.....77

60 EFFECT OF NON-RECEIPT OF APPROVALS/SEVERABILITY78

61 COMPLIANCE WITH LAWS.....78

62 CANCELLATION OF INTER-SE TRANSACTIONS.....79

63 CAPITAL AND DIVIDENDS79

64 COSTS79

SCHEDULE 1 – DETAILS OF IMMOVABLE PROPERTIES OF AMALGAMATING COMPANY NO. 180

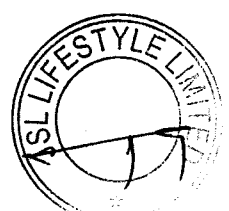
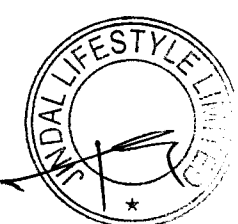
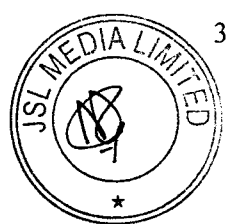
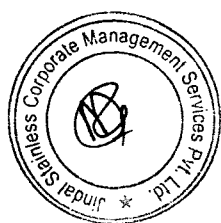
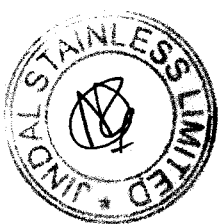
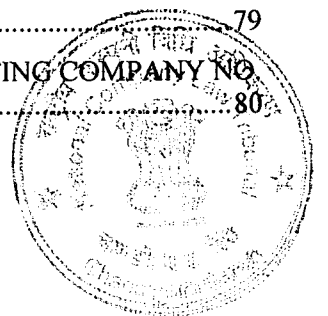

INTRODUCTION

1 PREAMBLE

This Composite Scheme of Arrangement (“Scheme”) is presented pursuant to the provisions of Sections 230 to 232 read with Section 66 and other applicable provisions of the Companies Act, 2013, and the rules and regulations issued thereunder and also read with Sections 2(1B) and 2(19AA) and the other applicable provisions of the Income-tax Act, 1961, in each case, as amended from time to time and as may be applicable, for:

- (i) Amalgamation of Jindal Stainless (Hisar) Limited (the “Amalgamating Company No. 1”) into and with Jindal Stainless Limited (the “Amalgamated Company”); and
(ii) Demerger of the Demerged Undertaking (as defined hereunder) of JSL Lifestyle Limited (the “Demerged Company”) and vesting of the same with and into Jindal Lifestyle Limited (the “Resulting Company”), on a going concern basis; and
(iii) Subsequent to the demerger of the Demerged Undertaking (as defined hereunder) of the Demerged Company (the “Amalgamating Company No. 2”), amalgamation of the Amalgamating Company No. 2 into and with the Amalgamated Company; and
(iv) Amalgamation of JSL Media Limited (the “Amalgamating Company No. 3”) into and with the Amalgamated Company; and
(v) Amalgamation of Jindal Stainless Corporate Management Services Private Limited (the “Amalgamating Company No. 4”) into and with the Amalgamated Company; and
(vi) Various other matters consequential or otherwise integrally connected herewith.

2 BACKGROUND AND DESCRIPTION OF THE PARTIES TO THIS SCHEME

a) Jindal Stainless Limited (“JSL”/“Amalgamated Company”) is a public limited company, incorporated under the Companies Act, 1956 (as amended) having its registered office at O.P. Jindal Marg, Hisar- 125005, Haryana.

The Amalgamated Company is engaged in the business of manufacturing stainless steel and stainless steel products. The equity shares of the Amalgamated Company are listed on the BSE (as defined hereunder) and the NSE (as defined hereunder). The Amalgamated Company GDS (as defined hereunder) are listed on the LuxSE (as defined hereunder). The Corporate Identity Number (“CIN”) of the Amalgamated Company is L26922HR1980PLC010901 and the Permanent Account Number (“PAN”) of the Amalgamated Company is AABCJ1969M. The Amalgamated Company is an associate of the Amalgamating Company No. 1.

b) Jindal Stainless (Hisar) Limited (“JSHL” / “Amalgamating Company No. 1”) is a public limited company, incorporated under the Act having its registered office at O.P. Jindal Marg, Hisar - 125005, Haryana.

The Amalgamating Company No. 1 is engaged in the business of manufacturing of stainless steel and stainless steel products and coin blanks. The equity shares of the Amalgamating Company No. 1 are listed on the BSE (as defined hereunder) and the NSE (as defined hereunder) and the Amalgamating Company No. 1 GDS (as defined hereunder) are listed on the LuxSE (as defined hereunder). The CIN of the Amalgamating Company No. 1 is L27205HR2013PLC049963 and the PAN of Amalgamating Company No. 1 is AAFCK5692N. The Amalgamated Company is an associate of the Amalgamating Company No. 1.

c) JSL Lifestyle Limited (“Demerged Company”) is a public limited company, incorporated under the provisions of the Companies Act, 1956 (as amended) and having its registered office at 48th K.M. Stone, Delhi Rothak Road, Village Rohad, Tehsil Bahadurgarh, Jhajjar, Haryana-124507.

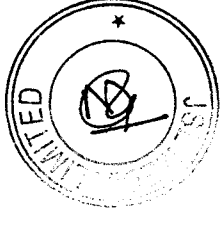
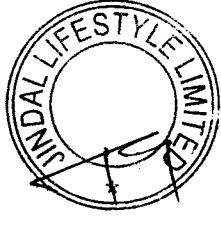
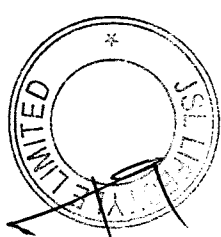

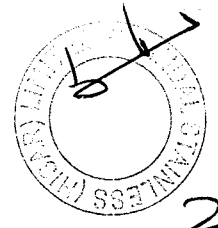
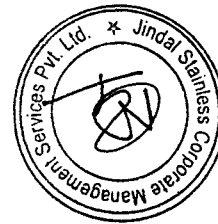
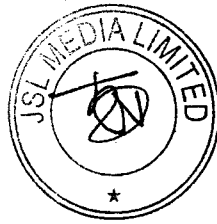
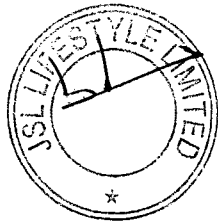
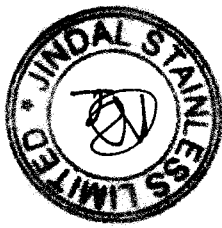

206

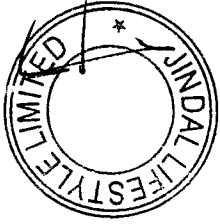

The Demerged Company is engaged in the business of manufacturing and supply of various components that have application in the mobility space and sale/supply of premium designer stainless steel kitchens and homeware, urban development infrastructural projects, stainless steel plumbing solutions and stainless steel value engineering offerings. The CIN of the Demerged Company is U74920HR2003PLC035976 and the PAN of the Demerged Company is AAFCA5161Q. The Demerged Company is a subsidiary of Amalgamating Company No. 1. The Demerged Company, after giving effect to Part C of this Scheme, is referred to herein as “Amalgamating Company No. 2”.

- d) **JSL Media Limited (“JML”/ “Amalgamating Company No. 3”)** is a public limited company incorporated under the provisions of the Companies Act, 1956 (as amended). The registered office of the Amalgamating Company No. 3 was changed from 28, Najafgarh Road, New Delhi, Delhi 110015 to JSL Complex, O.P. Jindal Marg, Hisar- 125005, Haryana on October 9, 2020.

The Amalgamating Company No. 3 is engaged in the advertising business. The CIN of the Amalgamating Company No. 3 is U70102HR2007PLC091299 and the PAN of the Amalgamating Company No. 3 is AAECPS027F. The Amalgamating Company No. 3 is a wholly owned subsidiary of the Amalgamating Company No. 1.

- e) **Jindal Stainless Corporate Management Services Private Limited (“JSCMS” / “Amalgamating Company No. 4”)** is a private limited company incorporated under the provisions of the Act having its registered office at O.P. Jindal Marg, Hisar- 125005, Haryana.

The Amalgamating Company No. 4 is engaged in the business of providing advisory and consultancy services to JSL, JSHL and the group companies. The shareholding of the Amalgamating Company No. 4 is currently held by the Amalgamated Company and the Amalgamating Company No. 1 in equal proportion, i.e., both the Amalgamated Company and the Amalgamating Company No. 1 hold 50% each of the total issued and paid up share capital of the Amalgamating Company No. 4. The CIN of the Amalgamating Company No. 4 is U74140HR2013PTC049340 and the PAN of the Amalgamating Company No. 4 is AADCJ5227E.

- f) **Jindal Lifestyle Limited (“Resulting Company”)** was incorporated as a public limited company under the provisions of the Act and having its registered office at C/o Jindal Stainless (Hisar) Limited, O.P. Jindal Marg, Hisar- 125005, Haryana.

The Resulting Company is proposed to engage in the business of manufacturing and sale/supply of stainless steel kitchens and homeware, urban development infrastructural projects, stainless steel plumbing solutions and stainless steel value engineering offerings. The CIN of the Resulting Company is U36109HR2020PLC091638 and the PAN of the Resulting Company is AAFCA5161Q. The Resulting Company is a wholly-owned subsidiary of the Demerged Company.

3 NEED AND RATIONALE FOR THIS SCHEME

3.1 Need for the Scheme

The management of the Companies (*as defined hereinafter*) is of the view that the stainless steel industry is poised for substantial growth in the near to medium term which opportunity can be better capitalised as a consolidated entity which has a bigger balance sheet, larger portfolio of products and services and a more streamlined structure. The management of the Companies further believes that the proposed consolidation will result into better efficiencies and economies of scale and in the post pandemic world, a single unified organisation is likely to have a faster growth trajectory. The consolidated organization is also expected to create more value for all the stakeholders.

206

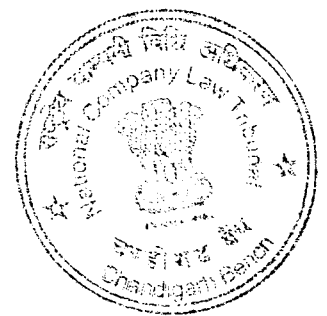

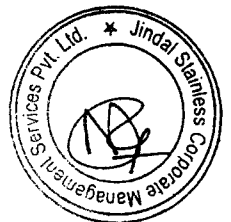
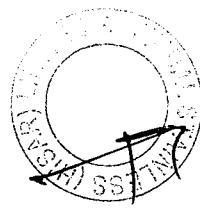
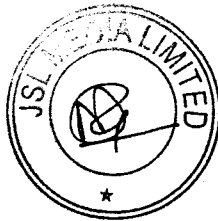
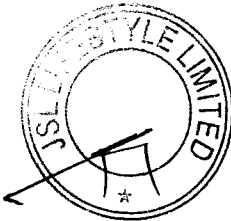

207

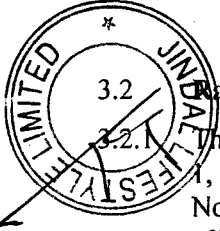

Rationale for the Scheme

- The Amalgamated Company proposes to enter into this Scheme with Amalgamating Company No. 1, Amalgamating Company No. 2, Amalgamating Company No. 3 and Amalgamating Company No. 4, to consolidate their respective manufacturing/service capabilities thereby increasing efficiencies in operations and use of resources, to consolidate their diversified product and services portfolio for improving overall customer satisfaction, to pool their human resource talent for optimal utilization of their expertise, to integrate the marketing and distribution channels for better efficiency, to have a larger market footprint domestically and globally, to simplify and streamline the group structure and to ensure optimization of working capital utilisation.
- 3.2.2 The management of the respective Companies are of the view that the amalgamations proposed in this Scheme is, in particular, expected to have the following benefits:
- Consolidation of the complementing strengths will enable the Amalgamated Company to have increased capability for offering diversified products and services on a single platform. Its enhanced resource base and client relationships are likely to result in better business potential and prospects for the consolidated entity and its stakeholders.
 - The combined financial strength is expected to further accelerate the scaling up of the operations of the Amalgamated Company. Deployment of resources in a more efficient manner is likely to enable faster expansion of the businesses of the Amalgamated Company.
 - The consolidation of funds and resources will lead to optimisation of working capital utilization and stronger financial leverage given the simplified capital structure, improved balance sheet, optimised management structure and consolidation of cross location talent pool.
 - The amalgamation will result in simplification of the group and business structure and will enable the consolidated entity to have a stronger global footprint and more extensive pan India network for deeper market penetration and enhancement of the overall customer satisfaction, engagement and retention.
- 3.2.3 Above all, since both, the Amalgamating Company No. 1 and the Amalgamated Company are companies belonging to the same promoter group which are engaged in manufacturing of stainless steel, the amalgamation pursuant to Part B of the Scheme will enable them to bring together their respective synergies in manufacturing of stainless steel thereby enhancing value for all the stakeholders.
- 3.2.4 The Scheme envisages demerger of the Demerged Undertaking and vesting of the same in the Resulting Company pursuant to Part C, to enable the Resulting Company and the Demerged Company to achieve optimum growth and development of their respective business operations post such demerger. The nature of risk and opportunities involved in both the businesses is divergent and capable of attracting different sets of investors. The management of the respective companies believe that both the businesses (i.e., Non-Mobility Business (*as defined hereinunder*) and Mobility Business (*as defined hereinunder*)) will benefit from separate focused management and separate investment strategy leading to development, expansion and growth for maximisation of stakeholder value.
- 3.2.5 After the demerger of the Demerged Undertaking and vesting of the same into the Resulting Company pursuant to Part C of the Scheme, the residual undertaking of the Amalgamating Company No. 2 which is engaged in the Mobility Business (*as defined hereinunder*) and therefore has a greater synergy with the business of the Amalgamated Company (manufacture of stainless steel and stainless steel products) would be amalgamated with the Amalgamated Company pursuant to Part D of the Scheme to tap the larger resources of the Amalgamated Company, enhance its productivity and efficiency of operations and logistics.
- 3.2.6 Amalgamation of the Amalgamating Company No. 3 pursuant to Part E will lead to a simplified and streamlined structure and help in better utilization of the resources and lead to operational efficiencies.

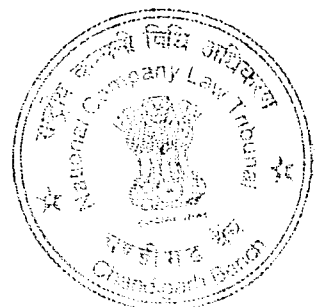

- 3.2.7 Amalgamation of the Amalgamating Company No. 4 pursuant to Part F will also lead to a simplified and streamlined structure and help in better utilization of the resources and lead to operational efficiencies.
- 3.2.8 The management of the respective Companies is of the view that this Scheme is in the interest of the customers, employees, lenders, shareholders and all other stakeholders of the respective Companies. Further, the Scheme will enable the synergies that already exist between the Amalgamating Companies and the Amalgamated Company in terms of services and resources to be used optimally for the benefit of their stakeholders.

4 OVERVIEW OF THIS SCHEME

4.1 This Scheme is divided into the following parts:

- PART A** - Definitions, Compliance with Tax Laws and Capital Structure
- PART B** - Amalgamation of Amalgamating Company No. 1 into and with Amalgamated Company, Change in Authorized Share Capital of the Amalgamated Company, Amendment to objects of Amalgamated Company, Dissolution of Amalgamating Company No. 1 and other related matters
- PART C** - Demerger of the Demerged Undertaking and vesting of the same in the Resulting Company, Reduction in Share Capital of the Resulting Company, Change in Authorised Share Capital of the Resulting Company and other related matters
- PART D** - Amalgamation of Amalgamating Company No. 2 into and with Amalgamated Company, Change in Authorised Share Capital of the Amalgamated Company, Dissolution of Amalgamating Company No. 2 and other related matters
- PART E** - Amalgamation of Amalgamating Company No. 3 into and with Amalgamated Company, Amendment to objects of Amalgamated Company, Dissolution of Amalgamating Company No. 3 and other related matters
- PART F** - Amalgamation of and Amalgamating Company No. 4 into and with Amalgamated Company, Amendment to objects of Amalgamated Company, Dissolution of Amalgamating Company No. 4 and other related matters
- PART G** - General Terms and Conditions applicable to the Scheme

4.2 Sequencing of the Scheme:

Subject to the provisions of Part G of this Scheme, upon this Scheme becoming effective on the Effective Date, the following shall be deemed to have occurred on the Appointed Date and shall become effective and operative in the sequence and in the order mentioned hereunder:

- (i) Amalgamation of Amalgamating Company No. 1 into and with the Amalgamated Company in accordance with Part B of this Scheme;
- (ii) Demerger of the Demerged Undertaking of the Demerged Company and vesting of the same with and into the Resulting Company in accordance with Part C of this Scheme;

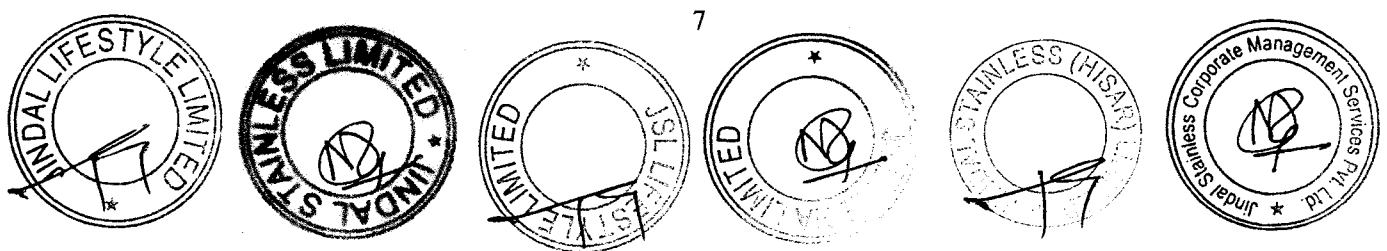
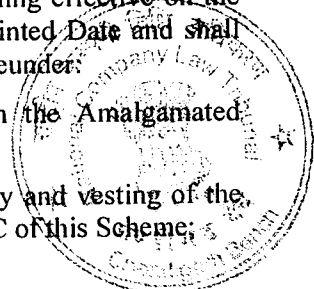

- (iii) Amalgamation of the Amalgamating Company No. 2 into and with Amalgamated Company in accordance with Part D of this Scheme;
- (iv) Amalgamation of Amalgamating Company No. 3 into and with Amalgamated Company in accordance with Part E of this Scheme; and
- (v) Amalgamation of Amalgamating Company No. 4 into and with Amalgamated Company in accordance with Part F of this Scheme.

PART A

DEFINITIONS, COMPLIANCE WITH TAX LAWS AND CAPITAL STRUCTURE

5 DEFINITIONS

In this Scheme, unless repugnant to the subject or meaning or context thereof, the following expressions shall have the meaning attributed to them as below:

- 5.1 “Act” means, as the context may admit, the Companies Act, 2013 (as may be notified from time to time) and the rules made thereunder, and shall include any statutory modifications, re-enactments or amendments thereof for the time being in force.
- 5.2 “Amalgamated Company” means Jindal Stainless Limited, as mentioned in the Para 2(a) of this Scheme.
- 5.3 “Amalgamated Company GDS” shall mean the Global Depository Shares issued by the Amalgamated Company pursuant to the Deposit Agreement with the Depository dated September 16, 2005 read with the amendment agreement dated December 21, 2015 and as amended from time to time.
- 5.4 “Amalgamating Companies” means collectively, Amalgamating Company No. 1, Amalgamating Company No. 2, Amalgamating Company No. 3 and Amalgamating Company No. 4, and shall, subject to the relevant provisions of the Scheme, include the whole of the business and undertakings of such Amalgamating Companies, including for each such Amalgamating Company:
 - a) all of its movable assets, movable, whether present or future, whether tangible or intangible and all rights, title, interests, covenants, undertakings and continuing rights in relation thereto;
 - b) all of its immovable properties and all its rights, title, interests, covenants, undertakings and continuing rights in relation thereto including all its land (together with all the buildings and structures standing thereon), whether freehold or leasehold;
 - c) all of its present and future liabilities, including contingent liabilities, charges and debts appertaining thereto;
 - d) all of its investments including shares and other securities, loans and advances, including interest and dividend accrued thereon;
 - e) all of its permits, rights, entitlements and licences (including the industrial or other licences) granted by any governmental, statutory or regulatory bodies, environmental clearances, permissions, approvals, consents, exemptions, subsidies, registrations, no-objection certificates, quotas, privileges, powers, offices, facilities whether granted/available/renewed/applied for;
 - f) all of its intellectual property rights, websites, emails, trade names, trademarks, service marks, copyrights, domain names, brand names, logos and applications therefor;
 - g) all of its indirect and direct tax credits, including but not limited to, ~~service tax credit,~~ CENVAT credit, GST credit, VAT credit, income - tax refunds, ~~carry forward losses,~~

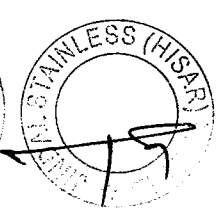
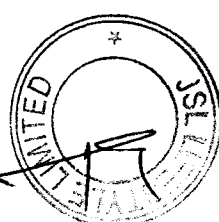
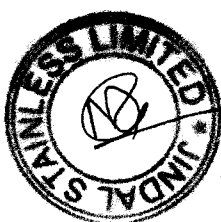

- unabsorbed depreciation, TDS, TCS, MAT credit entitlement, etc.;
- h) all of its privileges and benefits under all contracts, agreements, memoranda of understanding and all other rights powers and facilities of every kind and description whatsoever;
 - i) all of its debts, borrowings, obligations and liabilities, present or future or contingent, whether secured or unsecured;
 - j) all of its workmen and employees including those employed at its offices, factories and branches, and all other personnel employed by it;
 - k) all of the advance monies, earnest monies as may be lying with it and any and all of its security deposits, bank and contractual guarantees and other entitlements; and
 - l) all of its other properties, assets, liabilities, rights, obligations and employees, etc. of any nature whatsoever not covered under (a) to (k) above.
- 5.5 “**Amalgamating Company No. 1**” means Jindal Stainless (Hisar) Limited, as mentioned in Para 2(b) of this Scheme.
 - 5.6 “**Amalgamating Company No. 1 GDS**” shall mean the Global Depository Shares issued by the Amalgamating Company No. 1 pursuant to the Deposit Agreement with the Depository dated January 14, 2016 and as amended from time to time.
 - 5.7 “**Amalgamating Company No. 2**” means the residual Demerged Company after giving effect to the demerger of the Demerged Undertaking of the Demerged Company and vesting of the same in the Resulting Company.
 - 5.8 “**Amalgamating Company No. 3**” means JSL Media Limited, as mentioned in Para 2(d) of this Scheme.
 - 5.9 “**Amalgamating Company No. 4**” means Jindal Stainless Corporate Management Services Private Limited, as mentioned in Para 2(e) of this Scheme.
 - 5.10 “**Applicable Law(s)**” means all statutes, notifications, bye-laws, rules, regulations, guidelines, rules or common law, policies, codes, directives, ordinances, schemes or orders enacted or issued or sanctioned by any governmental authority, including any modification or re-enactment thereof for the time being in force.
 - 5.11 “**Appointed Date**” means the opening of business hours on April 1, 2020 or such other date as may be approved by the NCLT, with effect from which the Scheme will be deemed to be effective in the manner described in the Scheme.
 - 5.12 “**Board of Directors**” means the respective boards of directors of the Companies and shall, unless repugnant to the context or otherwise, include any duly authorized committee of directors or any person duly authorized by the Board of Directors or such committee of directors.
 - 5.13 “**BSE**” means BSE Limited and includes any successor thereof.
 - 5.14 “**Companies**” means collectively, Amalgamated Company, Amalgamating Company No. 1, Demerged Company/Amalgamating Company No. 2, Amalgamating Company No. 3, Amalgamating Company No. 4 and the Resulting Company.
 - 5.15 “**Court**” means the Chandigarh Bench of the Hon’ble National Company Law Tribunal (“NCLT”), or such other court, forum or authority as may be vested with any of the powers of the NCLT under the Act and/or as may be having jurisdiction for sanctioning this Scheme.
 - 5.16 “**Demerged Company**” means JSL Lifestyle Limited, as mentioned in the Para 2(c) of this Scheme, before giving effect to the demerger pursuant to Part C of this Scheme.
 - 5.17 “**Demerged Undertaking**” means the business undertaking of the Demerged Company engaged in the Non-Mobility Business, as a going concern, including all its assets, investments, rights, approvals, licenses and powers, leasehold rights and all its debts, outstanding liabilities, duties, obligations and employees, in each case, pertaining exclusively and solely to the Non-Mobility

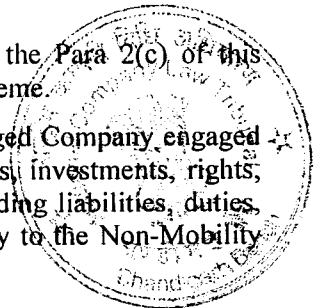
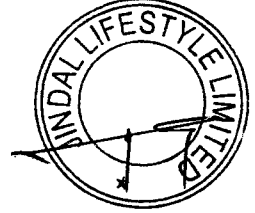
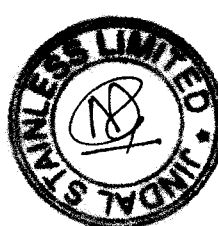
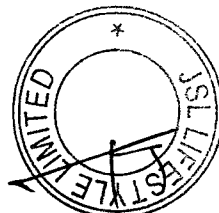
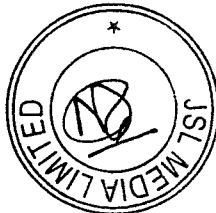
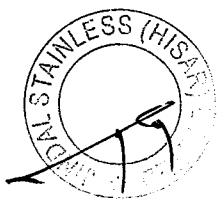

Business of the Demerged Company and including, but not limited to, the following:

- (i) all immovable properties i.e. land together with the buildings and structures standing thereon, whether freehold or leasehold, including share of any joint assets, which are currently being used exclusively and solely for the purpose of and in relation to the Non-Mobility Business of the Demerged Company and all related documents (including *panchnamas*, declarations, receipts) of title, rights and easements in relation thereto and all rights, covenants, continuing rights, title and interest in connection with the said immovable properties;
- (ii) all assets, as are movable in nature and exclusively and solely pertaining to and in relation to the Non-Mobility Business of the Demerged Company, whether present or future, tangible or intangible, including goodwill, whether recorded in the books or not and actionable claims, financial assets, investments (including in subsidiaries, associates and joint ventures in India) and loans and advances (including inter-unit receivables, if any, between the undertakings of the Demerged Company engaged in the Non-Mobility Business and the Mobility Business), pertaining to and in relation to the Non-Mobility Business of the Demerged Company including accrued interest or dividend thereon;
- (iii) all rights, licenses, privileges, claims, benefits, powers and facilities of every kind, nature and description whatsoever, exclusively and solely pertaining to and in relation to the Non-Mobility Business of the Demerged Company, including all assignments and grants thereof and all permits, clearances and registrations exclusively and solely pertaining to and in relation to the Non-Mobility Business of the Demerged Company;
- (iv) all taxes, share of advance tax, TDS, MAT credit, deferred tax benefits and other benefits in respect of the Non-Mobility Business of Demerged Company;
- (v) all provisions, funds, benefits of all agreements, contracts and arrangements and all other interests in connection with or relating to the Non-Mobility Business of the Demerged Company;
- (vi) all books, records, files, papers, computer programmes along with their licenses, manuals and back-up copies, advertising materials, and other data and records whether in physical or electronic form, in connection with or relating to the Non-Mobility Business of the Demerged Company;
- (vii) all employees and other personnel employed/engaged by the Demerged Company that are determined by its Board of Directors to be engaged in or in relation to the Non-Mobility Business of the Demerged Company on the date immediately preceding the Effective Date;
- (viii) all legal proceedings of whatsoever nature by or against or in relation to the Non-Mobility Business of the Demerged Company;
- (ix) all liabilities and obligations (including liabilities, allocable as per this Scheme, if any), whether present or future (including inter-unit payables, if any, between the undertakings of the Demerged Company engaged in the Non-Mobility Business and the Mobility Business) and the contingent liabilities pertaining to or relatable to the Non-Mobility Business of the Demerged Company. The liabilities pertaining to the Non-Mobility Business of the Demerged Company mean and include:
 - (a) All liabilities (including contingent liabilities) arising out of the activities or operations of the Non-Mobility Business of the Demerged Company, including in relation to or in connection with taxes or under or in relation to its contracts, obligations and duties;
 - (b) Specific loans and borrowings raised, incurred and utilized, if any, solely for the activities or operations of the Non-Mobility Business of the Demerged Company; and

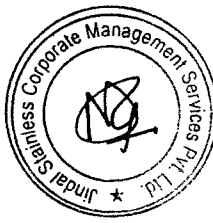
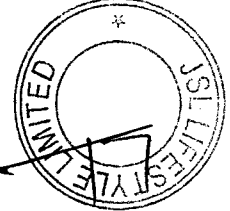
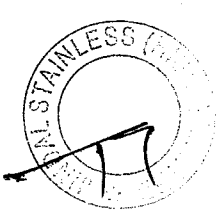
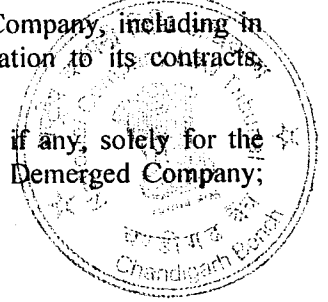

- (c) Liabilities other than those referred to above, which are general or multipurpose borrowings, if any, of the Demerged Company to be allocated to the Non-Mobility Business of the Demerged Company in the same proportion which the value of the assets transferred under Part C of this Scheme bears to the total value of the assets of the Demerged Company immediately before the Appointed Date of the Scheme in accordance with the provisions of Explanation 2 to the Section 2(19AA) of the IT Act.
- (x) any other asset (including any cash) specifically allocated by the Board of Directors of the Demerged Company for the Non-Mobility Business of the Demerged Company.

Any issue as to whether any asset or liability pertains to or is relatable to the Demerged Undertaking shall be mutually decided between the Board of Directors of the Demerged Company and the Resulting Company on the basis of evidence that they may deem relevant for the purpose (including the books or records of the Demerged Company).

- 5.18 "Depository" shall mean Citibank NA.
- 5.19 "Effective Date" means the date on which the order of the Court sanctioning the Scheme or any particular parts of the Scheme, is filed with the RoC.
Any references in this Scheme to "upon this Scheme becoming effective" or "effectiveness of this Scheme" shall be construed accordingly.
- 5.20 "Government" or "Governmental Authority" means any government authority, statutory authority, government department, agency, commission, board, tribunal or court or other law, rule or regulation making entity having or purporting to have jurisdiction on behalf of the Republic of India or any state or other subdivision thereof or any municipality, district or other subdivision thereof.
- 5.21 "GST" means goods and services tax.
- 5.22 "IT Act" means the Indian Income-tax Act, 1961 and the rules, regulations, circulars, notifications and orders issued thereunder including any statutory modifications, re-enactments or amendments thereof for the time being in force.
- 5.23 "LuxSE" means the Luxembourg Stock Exchange and includes any successor thereof.
- 5.24 "MAT" means minimum alternate tax.
- 5.25 "Mobility Business" means the business of the Demerged Company comprising of manufacturing and supply of various components that have application in the mobility space, such as, retention tanks, coaches, chassis, benches, grab poles, etc., in several grades for trains.
- 5.26 "Non-Mobility Business" means the business of the Demerged Company other than the Mobility Business and comprising of the manufacturing and sale/supply of stainless steel kitchens and homeware under its brand "Arc", premium designer stainless steel kitchens and home-ware solutions under its premium brand "Arttd'inox", urban development infrastructural projects, integrated stainless steel plumbing solutions and stainless steel value engineering offerings as original equipment manufacturers.
- 5.27 "NSE" means National Stock Exchange of India Limited and includes any successor thereof.
- 5.28 "Part B Record Date" has the meaning ascribed to it in Clause 15.1.
- 5.29 "Part C Record Date" has the meaning ascribed to it in Clause 24.1.
- 5.30 "Part D Record Date" has the meaning ascribed to it in Clause 34.1.
- 5.31 "RBI" means the Reserve Bank of India or any successor thereof.
- 5.32 "Registrar of Companies" or "RoC" means the Registrar of Companies, NCT of Delhi and Haryana and/or such other Registrar of Companies having jurisdiction over any of the Companies.

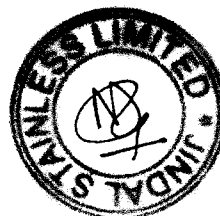
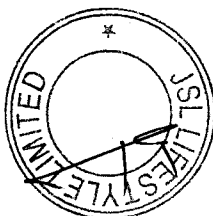
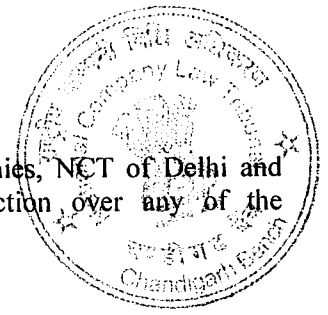

- 5.33 “**Resulting Company**” means Jindal Lifestyle Limited, as mentioned in the Para 2(f) of this Scheme.
- 5.34 “**Rs.**” means Indian Rupees being the lawful currency of the Republic of India.
- 5.35 “**Scheme of Arrangement**” or “**Scheme**” means this composite scheme of arrangement in its present form, or with or without any modification(s), as may be approved or imposed or directed by the Court, SEBI and any other Governmental Authority.
- 5.36 “**SEBI**” means the Securities and Exchange Board of India or any successor thereof.
- 5.37 “**SEBI Circular**” means the SEBI Master Circular bearing number SEBI/HO/CFD/DIL1/CIR/P/2020/249 dated December 22, 2020 consolidating SEBI circulars dated March 10, 2017, March 23, 2017, May 26, 2017, September 21, 2017, January 3, 2018, September 12, 2019 and November 3, 2020 *inter alia* in relation to the Scheme of Arrangement by Listed Entities.
- 5.38 “**Stock Exchanges**” means the NSE and BSE.
- 5.39 “**TCS**” means Tax Collected at Source.
- 5.40 “**TDS**” means Tax Deducted at Source.

The expressions, which are used but are not defined in this Scheme shall, unless repugnant or contrary to the context or meaning hereof, have the same meaning ascribed to them under the Act, the Securities Contracts (Regulation) Act, 1956, the Securities and Exchange Board of India Act, 1992 (including the rules, regulations made thereunder), the Depositories Act, 1996, the IT Act and other Applicable Laws.

6 COMPLIANCE WITH TAX LAWS

- 6.1 This Scheme, in so far as it relates to the demerger of the Demerged Undertaking of the Demerged Company into the Resulting Company pursuant to Part C of the Scheme, has been drawn up under Section 230-232 of the Act, to comply with the conditions relating to “Demerger” as specified under the tax laws, including Section 2(19AA) of the IT Act, which include the following:
- all the property of the Demerged Undertaking, being transferred by Demerged Company, immediately before the demerger, shall become the property of the Resulting Company, by virtue of the demerger;
 - all the liabilities relating to the Demerged Undertaking, being transferred by Demerged Company, immediately before the demerger, shall become the liabilities of the Resulting Company, by virtue of the demerger;
 - the property and the liabilities of the Demerged Undertaking, being transferred by Demerged Company, shall be transferred to the Resulting Company at values appearing in the books of account of the Demerged Company, as existing immediately before the demerger or in compliance with the Indian Accounting Standards specified in the Annexure to the Companies (Indian Accounting Standards) Rules, 2015;
 - the Resulting Company shall issue, in consideration of the demerger, its shares to the shareholders of Demerged Company (after giving effect to Part B of the Scheme) on a proportionate basis, except where the Resulting Company itself is a shareholder of the Demerged Company, if applicable;
 - the shareholders holding not less than three-fourths in value of the shares in the Demerged Company (other than shares already held therein immediately before the demerger by, or by a nominee for, the Resulting Company or, its subsidiary, if applicable) shall become shareholders of the Resulting Company by virtue of the demerger, otherwise than as a result of the acquisition of the property or assets of Demerged Company or any undertaking

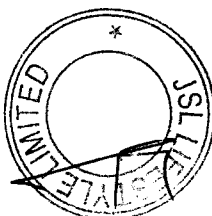

thereof by the Resulting Company;

- f) the transfer of the Demerged Undertaking shall be on a going concern basis; and
- g) comply with the other relevant sections (including Sections 47 and 72A) of the IT Act, as applicable.

6.2 This Scheme, in so far as it relates to the amalgamation of Amalgamating Company No. 1, Amalgamating Company No. 2, Amalgamating Company No. 3 and Amalgamating Company No. 4 into the Amalgamated Company, has been drawn up to comply with the conditions relating to "Amalgamation" as specified under the tax laws, including Section 2(1B) of the IT Act, which include the following:

- a) all the properties of the Amalgamating Companies immediately before the amalgamation shall become the property of the Amalgamated Company by virtue of the amalgamation;
- b) all the liabilities of the Amalgamating Companies immediately before the amalgamation shall become the liabilities of the Amalgamated Company by virtue of the amalgamation;
- c) shareholders holding not less than three-fourths in value of the shares in the Amalgamating Companies (other than shares already held therein immediately before the amalgamation by, or by a nominee for, the Amalgamated Company or its subsidiary) become shareholders of the Amalgamated Company by virtue of the amalgamation;

otherwise than as a result of the acquisition of the property of one company by another company pursuant to the purchase of such property by the other company or as a result of the distribution of such property to the other company after the winding up of the first-mentioned company;

and shall also comply with the other relevant sections (including Sections 47 and 72A) of the IT Act.

6.3 If any terms or provisions of this Scheme are found to be or interpreted to be inconsistent with any of the said provisions at a later date whether as a result of a new enactment or any amendment to any existing enactment or the coming into force of any provision of the IT Act or any other law or any judicial or executive interpretation or for any other reason whatsoever, the aforesaid provisions of the tax laws shall prevail and this Scheme (including any parts hereof) may be modified to comply with such laws or may be withdrawn at the discretion of the Board of Directors of the affected Companies provided however that no modification to the Scheme will be made which adversely affects the rights or interest of the secured creditors without seeking their approval. Further, such modification/withdrawal will not affect other Parts of the Scheme which have not been so modified or withdrawn.

7 CAPITAL STRUCTURE

7.1 Amalgamated Company

7.1.1 The authorised, issued, subscribed and paid-up share capital of the Amalgamated Company as on September 30, 2020 is as under:

Authorised Share Capital	Amount in Rs.
60,50,00,000 Equity Shares of ₹ 2 each	1,21,00,00,000
17,00,00,000 Preference Shares of ₹ 2 each	34,00,00,000
Total	1,55,00,00,000
Issued, Subscribed and Paid Up Share Capital	Amount in Rs.

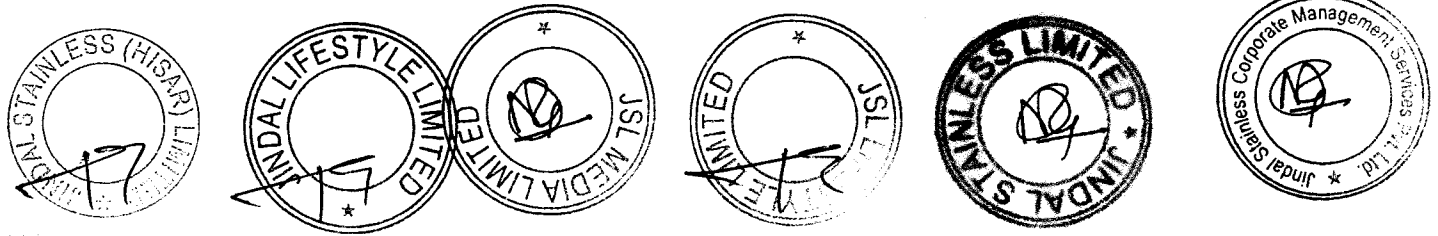
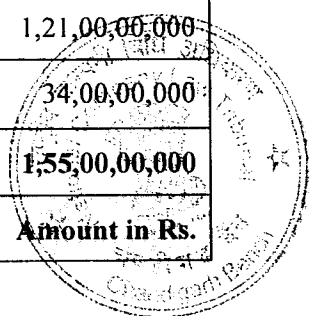

215

48,72,34,600* Equity Shares of ₹ 2 each fully paid up	97,44,69,200
Total	97,44,69,200

* Includes 88,02,167 (Eighty-eight lakh two thousand one hundred sixty seven) Amalgamated Company GDSs listed on the LuxSE representing 1,76,04,334 (One crore seventy-six lakh four thousand three hundred thirty four) equity shares of Rs.2/- (Rupees Two) each of the Amalgamated Company.

- 7.1.2 Further, the Amalgamated Company has issued 3,82,60,868 (Three crore eighty-two lakh sixty thousand eight hundred sixty-eight) convertible equity warrants ("Warrants") of the face value of Rs. 2/- (Rupees Two) each convertible into an equivalent number of the equity shares of the Amalgamated Company, to (a) Virtuous Tradecorp Private Limited, a promoter group company of the Amalgamated Company to the extent of 3,52,52,643 (Three crore fifty-two lakh fifty-two thousand six hundred forty-three) Warrants; and (b) to Kotak Special Situations Fund, an Alternate Investment Fund to the extent of 30,08,225 (Thirty lakh eight thousand two hundred twenty-five) Warrants.
- 7.1.3 Subsequent to September 30, 2020 and until the date of the Scheme being approved by the Board of Directors of the Amalgamated Company, there has been no change in the authorised, issued, subscribed and paid-up share capital of the Amalgamated Company, except to the extent of conversion of the aforesaid warrants, if any, issued by the Amalgamated Company.

7.2 Amalgamating Company No. 1

- 7.2.1 The authorised, issued, subscribed and paid-up share capital of the Amalgamating Company No. 1, as on September 30, 2020 is as under:

Authorised Share Capital	Amount in Rs.
24,00,00,000 Equity Shares of ₹ 2/- each	48,00,00,000
1,00,00,000 Preference Shares of ₹ 2/- each	2,00,00,000
Total	50,00,00,000
Issued, Subscribed and Paid Up Share Capital	Amount in Rs.
23,59,34,685* Equity Shares of ₹ 2/- each	47,18,69,370
Total	47,18,69,370

* Includes 75,52,167 (Seventy-five lakh fifty-two thousand one hundred sixty-seven) Amalgamating Company No. 1 GDS listed on the LuxSE representing 1,51,04,334 (One crore fifty-one lakh four thousand three hundred thirty-four) equity shares of Rs.2/- (Rupees Two) each of the Amalgamating Company No. 1.

- 7.2.2 Subsequent to September 30, 2020 and until the date of the Scheme being approved by the Board of Directors of the Amalgamating Company No. 1, there has been no change in the authorised, issued, subscribed and paid-up equity share capital of the Amalgamating Company No. 1.

7.3 Demerged Company / Amalgamating Company No.2

- 7.3.1 The authorised, issued, subscribed and paid-up share capital of the Demerged Company, as on September 30, 2020 is as under:

Authorised Share Capital	Amount in Rs.
--------------------------	---------------

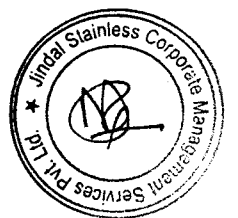
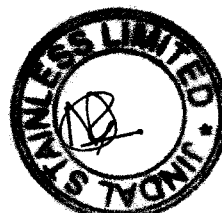
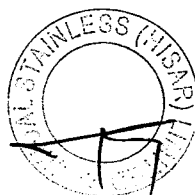
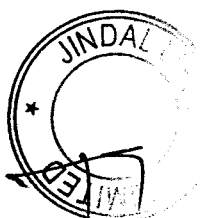
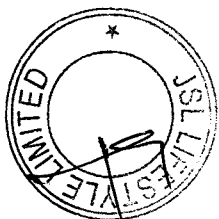
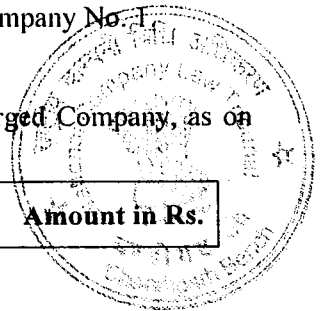

3,80,00,000 Equity Shares of ₹ 10/- each	38,00,00,000
Total	38,00,00,000
Issued, Subscribed and Paid Up Share Capital	Amount in Rs.
2,85,01,739 Equity Shares of ₹ 10/- each	28,50,17,390
Total	28,50,17,390

7.3.2 Subsequent to September 30, 2020 and until the date of the Scheme being approved by the Board of Directors of the Demerged Company, there has been no change in the authorised, issued, subscribed and paid-up equity share capital of the Demerged Company.

7.4 Amalgamating Company No. 3

7.4.1 The authorised, issued, subscribed and paid-up share capital of the Amalgamating Company No. 3, as on September 30, 2020 is as under:

Authorised Share Capital	Amount in Rs.
10,00,000 Equity Shares of ₹ 10/- each	1,00,00,000
Total	1,00,00,000
Issued, Subscribed and Paid Up Share Capital	Amount in Rs.
50,000 Equity Shares of ₹ 10/- each	5,00,000
Total	5,00,000

7.4.2 Subsequent to September 30, 2020 and until the date of the Scheme being approved by the Board of Directors of the Amalgamating Company No. 3, there has been no change in the authorised, issued, subscribed and paid-up equity share capital of the Amalgamating Company No. 3.

7.5 Amalgamating Company No. 4

7.5.1 The authorised, issued, subscribed and paid-up share capital of the Amalgamating Company No. 4, as on September 30, 2020 is as under:

Authorised Share Capital	Amount in Rs.
10,000 Equity Shares of ₹ 10/- each	1,00,000
Total	1,00,000
Issued, Subscribed and Paid Up Share Capital	Amount in Rs.
10,000 Equity Shares of ₹ 10/- each	1,00,000
Total	1,00,000

7.5.2 Subsequent to September 30, 2020 and until the date of the Scheme being approved by the Board of Directors of the Amalgamating Company No. 4, there has been no change in the authorised, issued, subscribed and paid-up equity share capital of the Amalgamating Company No. 4.

7.6 Resulting Company

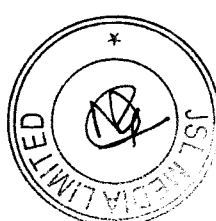
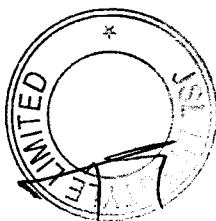
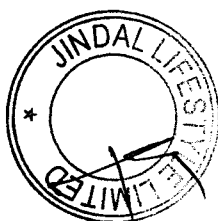

- 7.6.1 The authorised, issued, subscribed and paid-up share capital of the Resulting Company, as on December 16, 2020, i.e., date of its incorporation is as under:

Authorised Share Capital	Amount in Rs.
5,00,000 Equity Shares of ₹ 10/- each	50,00,000
Total	50,00,000
Issued, Subscribed and Paid Up Share Capital	Amount in Rs.
10,000 Equity Shares of ₹ 10/- each	1,00,000
Total	1,00,000

- 7.6.2 Subsequent to December 16, 2020 and until the date of the Scheme being approved by the Board of Directors of the Resulting Company, there has been no change in the authorised, issued, subscribed and paid-up equity share capital of the Resulting Company.

PART B
AMALGAMATION OF AMALGAMATING COMPANY NO. 1 INTO AND WITH THE
AMALGAMATED COMPANY

8 AMALGAMATION OF AMALGAMATING COMPANY NO. 1 INTO AND WITH THE AMALGAMATED COMPANY

- 8.1 Subject to the provisions of Part B and Part G of this Scheme in relation to the modalities of amalgamation, upon Part B of this Scheme becoming effective on the Effective Date and with effect from the Appointed Date, the Amalgamating Company No. 1 along with all its assets, liabilities, rights and obligations and its entire business and undertakings, including all its properties, rights, benefits and interests therein, shall by virtue of this Part B of the Scheme stand amalgamated with, transferred to and vested in the Amalgamated Company, and shall become the assets, liabilities, rights, obligations, business and undertakings of the Amalgamated Company, subject to the existing encumbrances thereon in favour of banks and financial institutions, if any (unless otherwise agreed to by such encumbrance holders), without any further act, instrument or deed being required from the Amalgamating Company No. 1 and/or the Amalgamated Company and without any approval or acknowledgement of any third party, in accordance with Sections 230 to 232 of the Act read with Section 2(1B) of the IT Act and all other applicable provisions of law if any, in accordance with the provisions contained herein.
- 8.2 Without prejudice to the generality of the above, in particular, the Amalgamating Company No. 1 shall stand amalgamated with the Amalgamated Company in the manner described in the subparagraphs below, subject to the existing encumbrances in favour of banks and financial institutions, if any (unless otherwise agreed to by such encumbrance holders):-

- (i) Upon Part B of this Scheme becoming effective on the Effective Date and with effect from the Appointed Date, all the assets (including investments) of the Amalgamating Company No. 1, that are movable in nature or incorporeal or intangible in nature or are otherwise capable of transfer by physical or constructive delivery and/or by endorsement and delivery or by transfer or by delivery instructions in relation to dematerialized shares or by vesting and recordal pursuant to the Scheme, including plant, machinery and equipment, shall stand transferred to and vested in and/or be deemed to be transferred to and vested in the Amalgamated Company and shall become the property and an integral

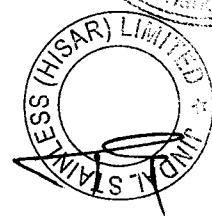
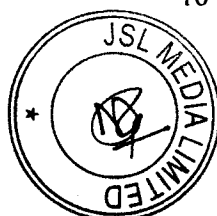
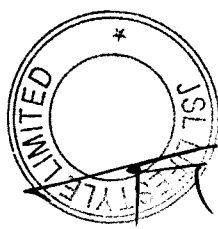
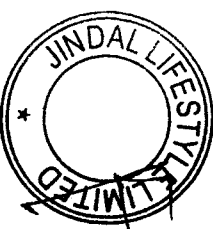

part of the Amalgamated Company, without any further act, instrument or deed required by either of the Amalgamating Company No. 1 or the Amalgamated Company and without any approval or acknowledgement of any third party. The transfer and vesting pursuant to this sub-clause shall be deemed to have occurred by physical or constructive delivery or by endorsement and delivery or by delivery instructions in relation to dematerialized shares or by vesting and recordal, pursuant to this Scheme, as appropriate to the property being transferred and vested and the title to such property shall be deemed to have been transferred and vested accordingly.

- (ii) Upon Part B of this Scheme becoming effective on the Effective Date and with effect from the Appointed Date, any and all other movable properties of the Amalgamating Company No. 1 (except those specified elsewhere in this Clause), including cash and cash equivalents, sundry debts and receivables, outstanding loans and advances, if any, recoverable in cash or in kind or for value to be received, actionable claims, bank balances and deposits, if any, with any person or body including without limitation any government, semi-government, local and other authorities and bodies, customers and other persons shall, without any further act, instrument or deed required by either of the Amalgamating Company No. 1 or the Amalgamated Company and without any approval or acknowledgement of any third party, become the property of the Amalgamated Company.
- (iii) Upon Part B of this Scheme becoming effective on the Effective Date and with effect from the Appointed Date, all immovable properties of the Amalgamating Company No. 1, including without limitation, all land together with all buildings and structures standing thereon and all rights and interests therein as set out in **Schedule 1** hereto (*Details of Immovable Properties of Amalgamating Company No.1*), whether freehold or leasehold or otherwise and all documents of title, rights and easements in relation thereto shall stand transferred and be vested in and/or be deemed to have been transferred vested in the Amalgamated Company and shall become the property and an integral part of the Amalgamated Company, without any further act, instrument or deed being required from the Amalgamating Company No. 1 and/or the Amalgamated Company and without any approval or acknowledgement of any third party. Upon Part B of the Scheme becoming effective on the Effective Date, the Amalgamated Company shall be entitled to exercise all rights and privileges attached to the aforesaid immovable properties and shall be liable to pay all rent, charges and taxes and fulfil all obligations in relation to or applicable to such immovable properties. The Amalgamated Company shall be entitled to seek mutation/substitution of title in its name in such immovable properties, for the purposes of information and record and such mutation / substitution of the title to and interest in such immovable properties shall be made and duly recorded in the name of the Amalgamated Company, by the appropriate authorities pursuant to the sanction of the Scheme by the Court and Part B of the Scheme becoming effective on the Effective Date in accordance with the terms hereof. However, it is hereby clarified that the absence of any such mutation/substitution shall not adversely affect the rights, title or interest of the Amalgamated Company in such immovable properties which shall be deemed to have been transferred to the Amalgamated Company automatically upon the Part B of the Scheme becoming effective on the Effective Date.
- (iv) Upon Part B of this Scheme becoming effective on the Effective Date and with effect from the Appointed Date, all debts, liabilities, contingent liabilities, duties and obligations, secured or unsecured, whether provided for or not in the books of accounts of the Amalgamating Company No. 1 or disclosed in the balance sheets of the Amalgamating Company No. 1 shall become and be deemed to be the debts, liabilities, contingent liabilities, duties and obligations of the Amalgamated Company without any further act, instrument or deed being required from the Amalgamating Company No. 1 and/or the Amalgamated Company and without any approval or acknowledgement of any third party. The Amalgamated Company undertakes to meet, discharge and satisfy the

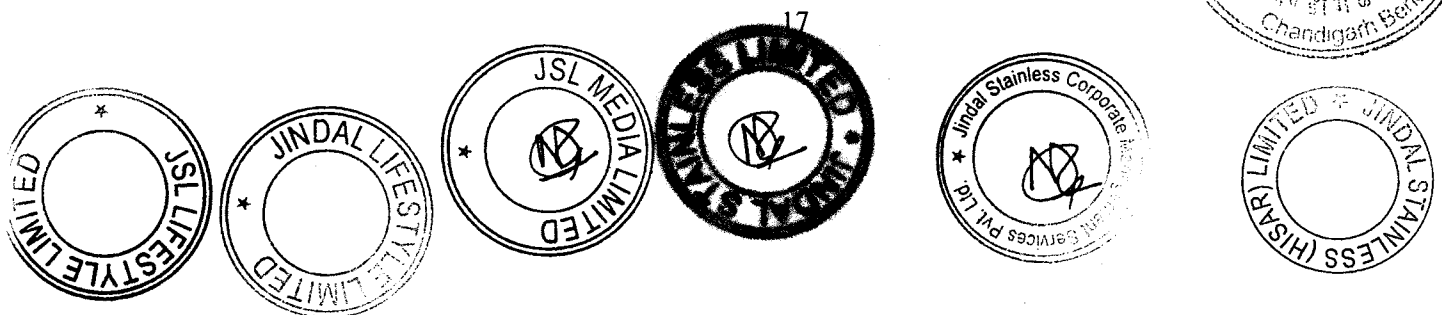
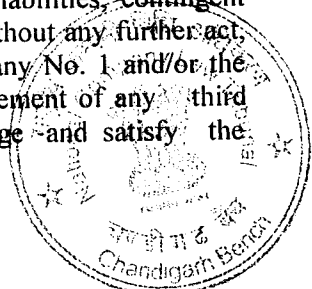

same in terms of their respective terms and conditions, if any. It is hereby clarified that it shall not be necessary to obtain the consent of any third party or other person, who is a party to any contract or arrangement by virtue of which such debts, liabilities, duties and obligations have arisen in order to give effect to the provisions of this sub-clause. However, the Amalgamated Company shall, if required, file appropriate forms with the RoC accompanied by the sanction order of the Court or a certified copy thereof and execute necessary deeds or documents in relation to creation/satisfaction/modification of charges to the satisfaction of the lenders, pursuant to Part B of this Scheme becoming effective in accordance with the terms hereof. The Amalgamated Company shall be entitled to take the benefit of all duties and charges already paid by the Amalgamating Company No. 1 for the creation/modification of any such security interest. Where any of the loans, liabilities and obligations have been discharged by the Amalgamating Company No. 1 after the Appointed Date but before the Effective Date, such discharge shall be deemed to have been done by the Amalgamating Company No. 1 for and on behalf of the Amalgamated Company.

- (v) Upon Part B of this Scheme becoming effective on the Effective Date and with effect from the Appointed Date, all loans, advances, trade receivables and other obligations or liabilities due from, or any guarantees or similar obligations undertaken on behalf of the Amalgamating Company No. 1 to / by the Amalgamated Company or *vice versa*, if any, and all contracts between the Amalgamating Company No. 1 and the Amalgamated Company shall stand automatically cancelled and terminated and shall be of no effect, without any further act, instrument or deed being required from either the Amalgamating Company No. 1 and/or the Amalgamated Company and without any approval or acknowledgement of any third party. No further taxes, fees, duties or charges shall be required to be paid by the Amalgamated Company on account of such cancellation or termination.
- (vi) Upon Part B of the Scheme coming into effect on the Effective Date and with effect from the Appointed Date, all incorporeal or intangible property of or in relation to the Amalgamating Company No. 1 shall stand transferred to and vested in the Amalgamated Company, and shall become the property and an integral part of the Amalgamated Company without any further act, instrument or deed required by either the Amalgamating Company No. 1 and/or the Amalgamated Company and without any approval or acknowledgement of any third party.
- (vii) Upon Part B of the Scheme coming into effect on the Effective Date and with effect from the Appointed Date, all letters of intent, memoranda of understanding, memoranda of agreements, tenders, bids, letters of award, expressions of interest, experience and/or performance statements, contracts, deeds, bonds, agreements, guarantees and indemnities, schemes, arrangements, undertakings and other instruments of every nature and description including without limitation, those relating to tenancies, privileges, powers and facilities of every kind and description, to which the Amalgamating Company No. 1 is a party or to the benefit of which the Amalgamating Company No. 1 may be eligible or under which the Amalgamating Company No. 1 is an obligor (except to the extent provided in this Clause) and which are subsisting or having effect immediately prior to Part B of the Scheme coming into effect on the Effective Date, shall be and shall remain in full force and effect against or in favour of the Amalgamated Company and may be enforced by or against it as fully and effectually as if, instead of the Amalgamating Company No. 1, the Amalgamated Company had been a party or beneficiary or obligee or obligor thereto, without any further act, instrument or deed being required from the Amalgamating Company No. 1 and/or the Amalgamated Company and without any approval or acknowledgement of any third party.
- (viii) Upon Part B of the Scheme coming into effect on the Effective Date and with effect from the Appointed Date, all statutory or regulatory licenses and permits including without limitation, all such licenses and permits as set out in, grants, allotments,

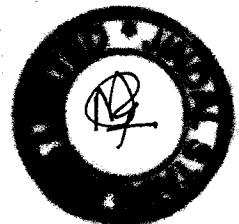
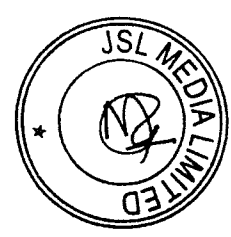
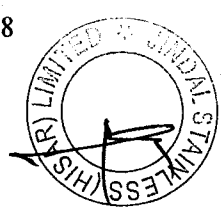
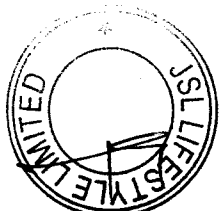
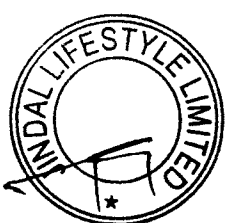
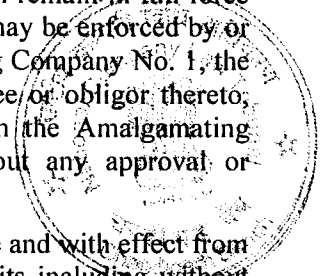

recommendations, no-objection certificates, permissions, registrations, approvals, certificates, consents, quotas, exemptions, clearances, tenancies, privileges, powers, offices, facilities, entitlements or rights (including licenses issued by the DGFT under EPCG Scheme, Advance Authorization Scheme, Focused Products Scheme, Focused Marketing Scheme, Duty Drawback Scheme and other schemes or approvals of a like nature issued by the DGFT) granted/available/renewed/applied for, to or by the Amalgamating Company No. 1 shall stand transferred to and vested in the Amalgamated Company, without any further act, instrument or deed being required by the Amalgamating Company No. 1 and/or the Amalgamated Company and without any approval or acknowledgement of any third party. Upon Part B of the Scheme coming into effect on the Effective Date, the Amalgamated Company shall be entitled to all the benefits thereof, and shall be liable for all the obligations thereunder. In relation to the same, any procedural requirements required to be fulfilled solely by Amalgamating Company No. 1 (and not by any of their successors), shall be fulfilled by the Amalgamated Company as if it is the duly constituted attorney of the Amalgamating Company No. 1. It is hereby clarified that if the consent or approval (by whatever name called) of any third party or authority is required to give effect to the provisions of this Clause, the said third party or authority shall duly record provide such consent or approval and shall make the necessary substitution/endorsement in the name of the Amalgamated Company pursuant to the sanction of this Scheme by the Court, and upon Part B of this Scheme becoming effective in accordance with the terms hereof. For this purpose, the Amalgamated Company may file appropriate applications/documents with relevant authorities concerned for information and record purposes. However, it is hereby clarified that the absence of any such substitution/endorsement shall not adversely affect the rights, benefits or interest of the Amalgamated Company which shall be deemed to have been transferred to the Amalgamated Company automatically upon the Part B of the Scheme becoming effective on the Effective Date.

- (ix) Upon Part B of the Scheme coming into effect on the Effective Date and with effect from the Appointed Date, all workmen and employees of the Amalgamating Company No. 1, who are on its payrolls and all other personnel employed by the Amalgamating Company No. 1 shall become employed by the Amalgamated Company with effect from the Effective Date, on such terms and conditions as are no less favourable than those on which they were engaged with the Amalgamating Company No. 1 immediately prior to the Effective Date, without any interruption of service as a result of this amalgamation and transfer. With regard to provident fund, gratuity fund, superannuation fund and any contributions required to be made in relation to employees under any statute or regulation, leave encashment and any other special scheme or benefits created or existing for the benefit of the personnel employed by the Amalgamating Company No. 1 immediately prior to Part B of the Scheme coming into effect on the Effective Date and transferred to the Amalgamated Company, the Amalgamated Company shall stand substituted for the Amalgamating Company No. 1 for all intents and purposes whatsoever, upon Part B of this Scheme becoming effective on the Effective Date, including with regard to the obligation to make contributions to the said funds in accordance with the provisions of such schemes or funds in the respective trust deeds or other documents and/or in accordance with the provisions of Applicable Laws or otherwise. All existing contributions made to such schemes and funds and all benefits accrued thereto shall also stand transferred in the name of the Amalgamated Company and all such benefits and schemes shall be continued by the Amalgamated Company for the benefit of such personnel employed by the Amalgamating Company No. 1 and transferred to the Amalgamated Company, on the same terms and conditions. Further, it is the aim and intent of the Scheme that all the rights, duties, powers and obligations of the Amalgamating Company No. 1 in relation to such schemes or funds shall become those of the Amalgamated Company. It is clarified that the services of all personnel employed by the Amalgamating Company No. 1 who are entitled to the benefits under

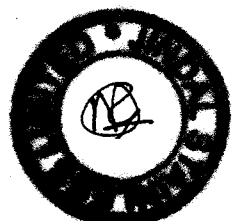
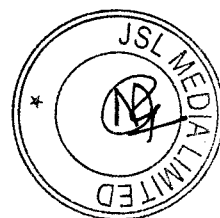
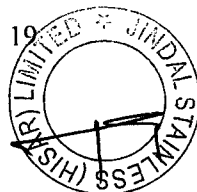
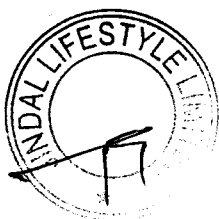

such schemes and funds, will be treated as having been continuous and uninterrupted for the purpose of the aforesaid schemes or funds.

- (x) Upon Part B of the Scheme coming into effect on the Effective Date the Amalgamated Company undertakes to continue to abide by any agreement(s)/settlement(s) entered into with any labour unions/employees by the Amalgamating Company No. 1. The Amalgamated Company agrees that for the purpose of payment of any future retrenchment compensation, gratuity and other terminal benefits, the past services of such employees, if any, with the Amalgamating Company No. 1, as the case may be, shall also be taken into account, and agrees and undertakes to pay the same as and when payable. Further, upon Part B of the Scheme coming into effect on the Effective Date, any prosecution or disciplinary action initiated, pending or contemplated against and any penalty imposed in this regard on any employee by the Amalgamating Company No. 1 shall be continued or shall continue to operate against the relevant employee and shall be enforced effectively by the Amalgamated Company.
- (xi) Upon Part B of the Scheme coming into effect on the Effective Date and with effect from the Appointed Date, all rights, entitlements, licenses, applications and registrations relating to trademarks, service marks, copyrights, domain names, brand name, logos, patents and other intellectual property rights of every kind and description, including without limitations, whether registered, unregistered or pending registration, and the goodwill arising therefrom, if any, to which the Amalgamating Company No. 1 is a party or to the benefit of which the Amalgamating Company No. 1 may be eligible or entitled, shall stand transferred to and vested in the Amalgamated Company, and shall become the rights, entitlement or property of the Amalgamated Company and shall be enforceable by or against the Amalgamated Company, as fully and effectually as if, instead of the Amalgamating Company No. 1, the Amalgamated Company had been a party or beneficiary or obligee thereto or the holder or owner thereof, without any further act, instrument or deed required by either of the Amalgamating Company No. 1 or the Amalgamated Company and without any approval or acknowledgement of any third party.
- (xii) Upon Part B of the Scheme coming into effect on the Effective Date and with effect from the Appointed Date, the Amalgamated Company shall be entitled to the benefit of all insurance policies (if any) which have been issued in respect of Amalgamating Company No. 1 and/or any of its assets or employees and the name of the Amalgamated Company shall stand substituted as the "Insured" in all such policies as if the Amalgamated Company was originally a party thereto without any further act, instrument or deed required by either of the Amalgamating Company No. 1 or the Amalgamated Company and without any approval or acknowledgement of any third party. Further, the Amalgamated Company shall be entitled to the benefit of all claims filed, prosecuted, proposed to be filed, pending and/or adjudicated in relation to all insurance policies issued in respect of Amalgamating Company No. 1 and/or any of its assets or employees.
- (xiii) Upon Part B of the Scheme coming into effect on the Effective Date and with effect from the Appointed Date, all taxes and duties of whatsoever description (including but not limited all carry forward tax losses comprising of unabsorbed depreciation, advance tax payments, TDS, TCS, MAT, securities transaction tax, taxes withheld/paid in a foreign country, customs duty, entry tax, value added tax, GST, sales tax, service tax etc.) payable by or refundable to the Amalgamating Company No. 1, including all or any refunds or claims shall be treated as the tax liability or refunds/claims, as the case may be, of the Amalgamated Company, and any tax incentives, advantages, privileges, exemptions, credits, holidays, remissions, reductions etc., as would have been available to the Amalgamating Company No. 1, shall pursuant to this Scheme becoming effective, be available to the Amalgamated Company without any further act, instrument or deed required by either of the Amalgamating Company No. 1 or the Amalgamated Company and without any approval or acknowledgement of any third party but in the manner more

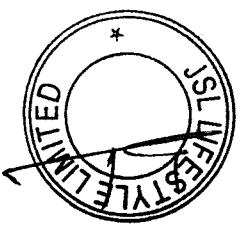
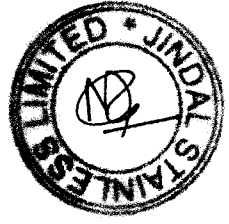
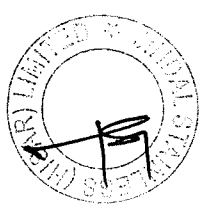
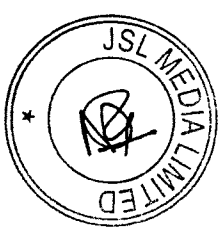
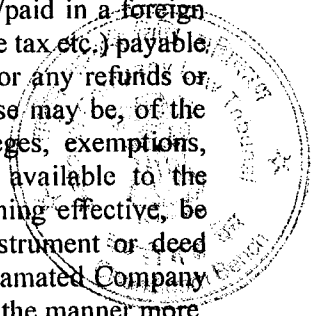

particularly set out herein below. Upon Part B of the Scheme coming into effect on the Effective Date and with effect from the Appointed Date, all existing and future incentives, un-availed credits and exemptions, benefit of carried forward losses and other statutory benefits, including in respect of income tax (including MAT), excise (including Modvat/ Cenvat), customs, value added tax, sales tax, service tax to which the Amalgamating Company No. 1 is entitled shall be available to and shall stand transferred and vested in the Amalgamated Company without any further act, instrument or deed required by either the Amalgamated Company or the Amalgamating Company No. 1 and without any approval or acknowledgement of any third party. Upon Part C of the Scheme coming into effect on the Effective Date and with effect from the Appointed Date, any tax deducted at source deducted by or on behalf of the Amalgamating Company No. 1 until the Effective Date shall be deemed to have been deducted on behalf of the Amalgamated Company.

(xiv) Upon Part B of the Scheme coming into effect on the Effective Date and with effect from the Appointed Date, the Amalgamated Company shall be entitled to claim the benefit of any and all corporate approvals and limits as may have already been taken by the Amalgamating Company No. 1, including without limitation, the approvals and limits under Sections 62, 179, 180, 185, 186, 188 etc., of the Act, until the time the same are duly modified by the Amalgamated Company.

(xv) Upon Part B of the Scheme coming into effect on the Effective Date and with effect from the Appointed Date, all other estates, assets, rights, title, interests and authorities accrued to and/or acquired by the Amalgamating Company No. 1 shall be deemed to have been accrued to and/or acquired for and on behalf of the Amalgamated Company and shall, upon Part B of this Scheme coming into effect, pursuant to the provisions of the Act, without any further act, instrument or deed be and stand transferred to or vested in and/or be deemed to have been transferred to or vested in the Amalgamated Company to that extent and shall become the estates, assets, right, title, interests and authorities of the Amalgamated Company.

(xvi) Upon Part B of the Scheme coming into effect on the Effective Date, all books, record files, papers, computer programs, engineering and process information, manuals, data, production methodologies, production plans, designs, catalogues, quotations, websites, cloud storage, sales and advertising material, marketing strategies, list of present and former customers, customer credit information, customer pricing information, and other records whether in physical form or electronic form or in any other form in connection with or relating to the Amalgamating Company No. 1 shall be deemed to have been transferred to or acquired for and on behalf of the Amalgamated Company and shall, upon Part B of this Scheme coming into effect, without any further act, instrument or deed be and stand transferred to or vested in and/or be deemed to have been transferred to or vested in the Amalgamated Company.

(xvii) Upon Part B of the Scheme coming into effect on the Effective Date and with effect from the Appointed Date, the Amalgamated Company shall bear the burden and the benefits of any legal, tax, quasi-judicial, administrative, regulatory or other proceedings initiated by or against the Amalgamating Company No. 1. If any suit, appeal or other proceeding of whatsoever nature by or against the Amalgamating Company No. 1 shall be pending as on the Effective Date, the same shall not abate, be discontinued or in any way be prejudicially affected by reason of the merger of such Amalgamating Company No. 1 and transfer and vesting of the same in the Amalgamated Company or of anything contained in Part B of this Scheme but the proceedings may be continued, prosecuted and enforced by or against the Amalgamated Company in the same manner and to the same extent as it would or might have been continued, prosecuted and enforced by or against the Amalgamating Company No. 1 as if Part B of this Scheme had not been made effective. Upon Part B of the Scheme becoming effective, the Amalgamated Company undertakes to have such legal or other proceedings initiated by or against the Amalgamating Company No. 1 transferred in its name and to have the same continued, prosecuted and enforced by or against the

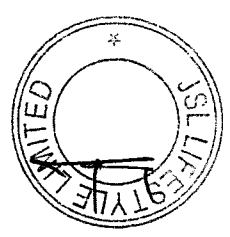
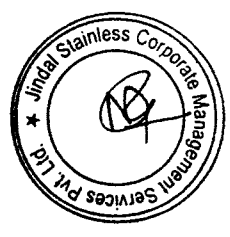
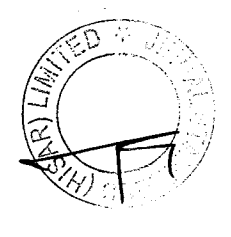
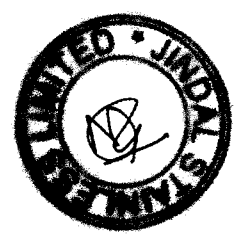
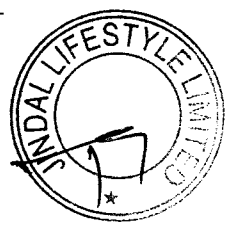
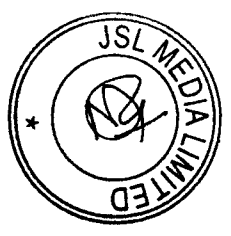
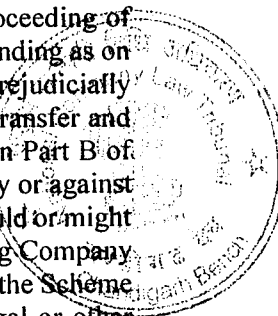

Amalgamated Company to the exclusion of the Amalgamating Company No. 1. The Amalgamated Company also undertakes to handle all legal or other proceedings which may be initiated against the Amalgamating Company No. 1 after the Effective Date in its own name and account and further undertakes to pay all amounts including interest, penalties, damages etc., pursuant to such legal/ other proceedings.

8.3 Upon Part B of the Scheme coming into effect on the Effective Date with effect from the Appointed Date, the Amalgamated Company shall be entitled to the benefit of the past experience, accreditation and/or performance of the Amalgamating Company No. 1 for all purposes without any further act, instrument or deed required by either of the Amalgamating Company No. 1 or the Amalgamated Company and without any approval or acknowledgement being required from any third party. If any instrument or deed or document is required or deemed necessary or expedient to give effect to the provisions of this Clause by the Amalgamated Company, the Amalgamated Company shall, under the provisions of Part B of the Scheme, be deemed to be duly authorized to execute all such writings on behalf of the Amalgamating Company No. 1 and to carry out or perform all such formalities or compliances referred to above on behalf of the Amalgamating Company No. 1.

9 CONDUCT OF AFFAIRS UNTIL THE EFFECTIVE DATE

9.1 In the event Part B of this Scheme becomes effective and with effect from the Appointed Date and up to and including the Effective Date:

- (i) the Amalgamating Company No. 1 shall be deemed to have carried on the business activities of the Amalgamating Company No. 1 and stand possessed of the properties and assets of the Amalgamating Company No. 1, for, on behalf of and in trust for, the Amalgamated Company; and
- (ii) all profits or income accruing to or received by the Amalgamating Company No. 1 and all taxes paid thereon (including but not limited to advance tax, tax deducted at source, tax collected at source, minimum alternate tax, fringe benefit tax, securities transaction tax, taxes withheld/paid in a foreign country, customs duty, entry tax, value added tax, goods and services tax, sales tax, service tax etc.) or losses arising in or incurred by the Amalgamating Company No. 1 shall, for all purposes, be treated as and deemed to be the profits, income, taxes or losses, as the case may be, of the Amalgamated Company.

9.2 The Amalgamated Company shall also be entitled, pending the sanction of this Scheme, to apply to the central government, state government, and all other agencies, departments, statutory authorities and Governmental Authorities concerned, wherever necessary, for such consents, approvals and sanctions which the Amalgamated Company may require including the registration, approvals, exemptions, reliefs, etc., as may be required/granted under any Applicable Law for the time being in force for carrying on the business of the Amalgamating Company No. 1.

10 TREATMENT OF TAXES

10.1 Upon Part B of this Scheme becoming effective and with effect from the Appointed Date, any surplus in the provision for taxation/ duties/ levies account including but not limited to the advance tax, TDS or TCS and MAT credit, CENVAT credit or, GST Credit, as on the date immediately preceding the Appointed Date will also be transferred from the Amalgamating Company No. 1 to the Amalgamated Company. Any refund under the IT Act or other Applicable Laws dealing with taxes/ duties/ levies, including GST, allocable or related to the business of Amalgamating Company No. 1 or due to the Amalgamating Company No. 1, consequent to the assessment made in respect of the Amalgamating Company No. 1, for which no credit is taken in

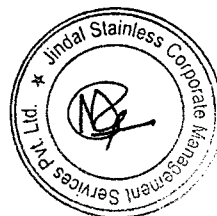
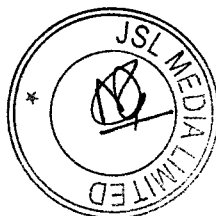
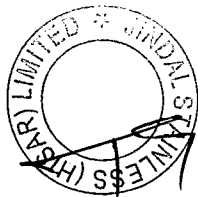
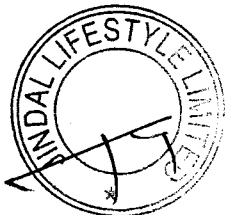
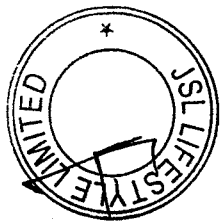

the book of accounts of the Amalgamating Company No. 1 as on the date immediately preceding the Appointed Date, shall also belong to and be received by the Amalgamated Company and shall be deemed to have been on account of or paid by the Amalgamated Company and the relevant Governmental Authorities shall be bound to transfer to the account of and give credit for the same to the Amalgamated Company upon the approval of this Scheme by the Court and upon relevant proof and documents being provided to the said authorities.

- 10.2 Without prejudice to the generality of the above, deductions, benefits, right to carry forward and set off accumulated losses and unabsorbed depreciation, and credits (including but not limited to MAT/CENVAT credits etc.) under the IT Act, Goods and Services Tax or Service Tax, any other central government / state government incentive schemes etc., to which the Amalgamating Company No. 1 are/ would be entitled to in terms of the Applicable Laws of the central and state government or of any foreign jurisdictions, shall be available to and vest in the Amalgamated Company.
- 10.3 Upon Part B of this Scheme becoming effective and with effect from the Appointed Date, the tax payments (including without limitation income tax, GST, tax on distribution of dividends, excise duty, central sales tax, custom duty, applicable state value added tax and entry tax or any other taxes as may be applicable from time to time) whether by way of tax deducted at source or collected at source by the parties, advance tax or otherwise howsoever, by the Amalgamating Company No. 1 on or after the Appointed Date, shall be deemed to be paid by the Amalgamated Company and the Amalgamated Company shall be entitled to claim credit for such taxes/duties paid against its tax/ duty liabilities, notwithstanding that the certificates/ challans or other documents for payment of such taxes/duties are in the name of Amalgamating Company No. 1.
- 10.4 Upon Part B of the Scheme becoming effective on the Effective Date and with effect from the Appointed Date, the Amalgamating Company No. 1 and the Amalgamated Company are expressly permitted to prepare and/or revise, as the case may be, their financial statements and statutory / tax returns along with the prescribed forms, filings and annexures under the IT Act and/or in relation to central sales tax, custom duty, entry tax, applicable state value added tax, GST and other tax laws, if required, to give effect to the provisions of the Scheme.
- 10.5 Upon Part B of this Scheme becoming effective and with effect from the Appointed Date, all inter-party transactions between Amalgamating Company No. 1 and the Amalgamated Company shall be considered as intra-party transactions for all purposes (including for tax compliances, credits, refunds, etc.).
- 10.6 Upon Part B of this Scheme becoming effective and with effect from the Appointed Date, obligation for deduction of tax at source on any payment made by or to be made by the Amalgamating Company No. 1 or for collection of tax at source on any supplies made by or to be made by Amalgamating Company No. 1 shall be made or deemed to have been made and duly complied with by the Amalgamated Company. Further, any tax deducted at source or collected at source by the Amalgamating Company No. 1 and Amalgamated Company on transactions with each other, if any (from the Appointed Date until Effective Date) and deposited with Governmental Authorities shall be deemed to be advance tax paid by the Amalgamated Company and shall, in all proceedings be dealt with accordingly.
- 10.7 Upon Part B the Scheme coming into effect on the Effective Date and with effect from the Appointed Date, all tax compliances under any tax laws by the Amalgamating Company No. 1 on or after the Appointed Date shall be deemed to be made by the Amalgamated Company.
- 10.8 Upon Part B of this Scheme becoming effective and with effect from the Appointed Date, all tax assessment proceedings and appeals of whatsoever nature by or against the Amalgamating Company No. 1, pending or arising as at the Effective Date, shall be continued and/enforced by or against the Amalgamated Company in the same manner and to the same extent as would or might have been continued and enforced by or against the Amalgamating Company No. 1. Further, the aforementioned proceedings shall neither abate or be discontinued nor be in any way prejudicially affected by the reason of the amalgamation of the Amalgamating Company No. 1

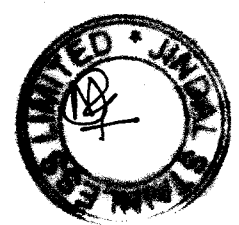
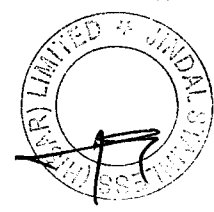
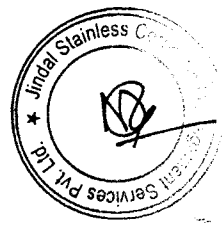
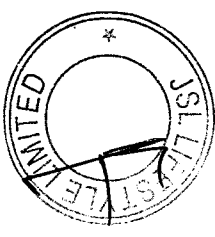
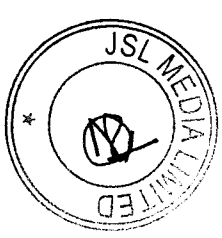
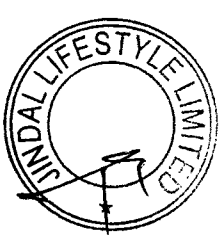
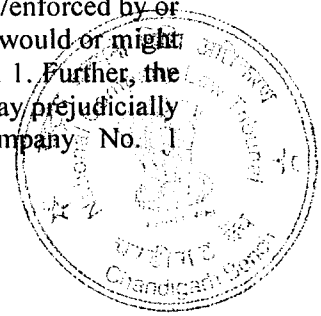

with the Amalgamated Company or anything contained in Part B of this Scheme.

- 10.9 Upon Part B of this Scheme becoming effective and with effect from the Appointed Date, all the expenses incurred by the Amalgamating Company No. 1 and the Amalgamated Company in relation to the amalgamation of the Amalgamating Company No. 1 with the Amalgamated Company as per this Scheme, including stamp duty expenses and / or transfer charges, if any, shall be allowed as deduction to Amalgamated Company in accordance with Section 35DD of the IT Act over a period of 5 (five) years beginning with the previous year in which Part B of the Scheme becomes effective.
- 10.10 Upon Part B of this Scheme becoming effective and with effect from the Appointed Date, all the deductions otherwise admissible to the Amalgamating Company No. 1, including payment admissible on actual payment or on deduction of appropriate taxes or on payment of TDS (like Section 43B, Section 40, Section 40A etc. of the IT Act) will be eligible for deduction to the Amalgamated Company upon fulfilment of required conditions under the IT Act.
- 10.11 The amalgamation under this Scheme is in compliance with the IT Act, specifically Section 2(1B) and other relevant provisions. If any of the terms of this Scheme are inconsistent with the provisions of Sections 2(1B) of the IT Act, the provisions of Sections 2(1B) of the IT Act shall to the extent of such inconsistency, prevail and this the Scheme shall, stand and be deemed to be modified to that extent to comply with the said provisions and such modifications shall not affect the other Parts of this Scheme.

11 CONDUCT OF AFFAIRS AFTER THE EFFECTIVE DATE

11.1 The Amalgamated Company, shall, at any time after Part B of this Scheme becomes effective on the Effective Date, in accordance with the provisions hereof, if so required under any law, contract or otherwise, be entitled to do and take all such actions as may be required to give full effect to the provisions of this Part B and for this purpose the Amalgamated Company shall, under the provisions hereof, be deemed to be authorised on behalf of the Amalgamating Company No. 1. Without prejudice to the generality of the above, the Amalgamated Company shall be entitled and deemed to be authorised to:-

- (i) execute appropriate deeds of confirmation or other writings or arrangements with any party to any contract or arrangement (including without limitation any bank guarantee, performance guarantee, fixed deposit, letters of credit, bill of entry etc.) in relation to which the Amalgamating Company No. 1 have been a party or to the benefit of which the Amalgamating Company No. 1 may have been entitled, and to make any filings with the Governmental Authorities, in order to give formal effect to the provisions of Part B of the Scheme; and
- (ii) do all such acts or things as may be necessary to effectually transfer/obtain in favour of the Amalgamated Company the approvals, consents, bids, awards, tenders, exemptions, registrations, no-objection certificates, permits, quotas, rights, entitlements, licenses and certificates etc. which were held or enjoyed by the Amalgamating Company No. 1 including without limitation, execute all necessary or desirable writings and confirmations on behalf of the Amalgamating Company No. 1 and to carry out and perform all such acts, formalities and compliances as may be required in this regard.

11.2 The provisions of this Clause shall operate notwithstanding anything to the contrary contained in any deed or writing or certificate or license or the terms of sanction or issue or any security, all of which instruments and documents shall stand modified and/or superseded by the foregoing provisions.

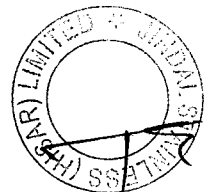
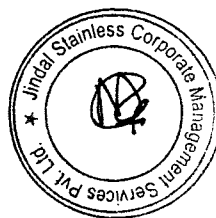
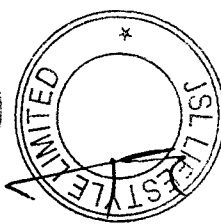
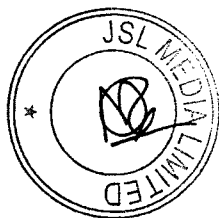
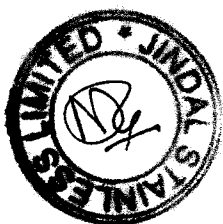
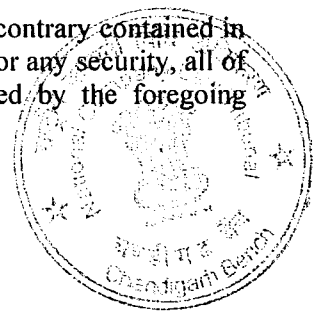

12 SAVING OF CONCLUDED TRANSACTIONS

Except as expressly provided hereunder including in Clause 10.4 and Clause 10.5, the transfer of properties and liabilities to, and the continuance of proceedings by or against, the Amalgamated Company as envisaged in this Part B shall not affect any transaction or proceedings already concluded by the Amalgamating Company No. 1 on or before the Appointed Date and after the Appointed Date and until the Effective Date, and to such end and intent the Amalgamated Company accepts and adopts all acts, deeds and things done and executed by the Amalgamating Company No. 1 in respect thereto as done and executed on behalf of itself.

13 CHANGE IN AUTHORISED SHARE CAPITAL OF THE AMALGAMATED COMPANY

- 13.1 Upon this Scheme becoming effective on the Effective Date, the authorised share capital of Amalgamating Company No. 1 as on the Effective Date shall stand transferred to and be merged/amalgamated with the authorised share capital of the Amalgamated Company, and the fee, if any, paid by the Amalgamating Company No. 1 on its authorised share capital shall be set off against any fee payable by the Amalgamated Company on such increase in its authorised share capital, consequent to the amalgamation. Accordingly, Clause V of the Memorandum of Association of the Amalgamated Company shall stand modified and shall read as under:-

“The Authorised Share Capital of the Company is Rs. 205,00,00,000 (Rupees Two Hundred Five Crore) consisting of 84,50,00,000 (Eighty four crore fifty thousand) Equity Shares having face value of Rs. 2 (Rupees Two) and 18,00,00,000 (Eighteen crore) preference share having face value of Rs. 2 (Rupees Two).”

- 13.2 It is hereby clarified that the consent of the shareholders of the Amalgamated Company and shareholders of the Amalgamating Companies to Part B of this Scheme shall be sufficient for the purposes of effecting the aforesaid additions in the Memorandum of Association of the Amalgamated Company and that no further resolutions, whether under the applicable provisions of the Act or under the Articles of Association, shall be required to be separately passed. All actions taken in accordance with this Clause shall be deemed to be in full compliance of Sections 61 and 64 and other applicable provisions of the Act and rules and regulations issued thereunder and no further resolutions or actions under any other provisions of the Act or the rules or regulations issued thereunder would be required to be separately passed or undertaken by the Amalgamated Company.

14 AMENDMENT TO OBJECTS OF THE AMALGAMATED COMPANY

- 14.1 Upon Part B of the Scheme becoming effective from the Effective Date, the following sub-clause shall be deemed to have been automatically added to Clause III (A) (Main Objects) of the Memorandum of Association of the Amalgamated Company immediately after the existing sub-clauses of Clause III (A) and the “Objects Clause” in the Memorandum of Association of the Amalgamated Company shall be deemed to have been amended to that extent by inserting below clause in the main objects of the Amalgamated Company:-

“To carry on all or any of the business concerning arms and ammunition, auto parts, and rail coach / wagon / locomotives relating to:

- i. *developing, manufacturing, including assemblies/sub-assemblies/components raw-materials, tools, jigs, fixtures etc., proof testing, testing, marketing including engagement of purchase dealers, import and export agents, representatives and after sales support.*
- ii. *setting up necessary infrastructure, including civil works and plant and machinery to support (i) above including laser cut/ press, formed/ welded/ roll formed parts/ components/ products, steel pipes and tubes and pipe fittings, iron and steel products, cast iron and steel and tubular structural.*
- iii. *manpower placement commensurate with the activities at (i) and (ii) above.*

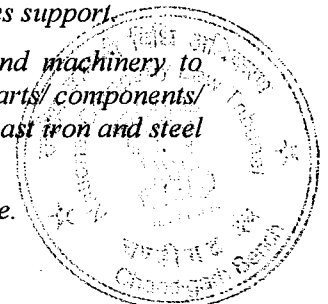
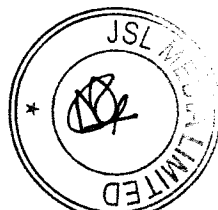
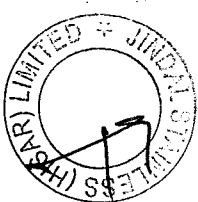

iv. *all such activities as necessary and/or expedient to apply for, obtain and maintain in force, certifications / licences from various regulatory or certification authorities in India or abroad in connection with any of the aforesaid activities.”*

14.2 It is hereby clarified that the consent of the shareholders of the Amalgamated Company and shareholders of the Amalgamating Companies to Part B of this Scheme shall be sufficient for the purposes of effecting the aforesaid amendments in the “Objects Clause” in the Memorandum of Association of the Amalgamated Company and that no further resolutions, under the applicable provisions of the Act, shall be required to be separately passed. All actions taken in accordance with this Clause 14 of Part B of this Scheme shall be deemed to be in full compliance of Section 13 and other applicable provisions of the Act and rules and regulations issued thereunder and no further resolutions or actions under any other provisions of the Act or the rules or regulations issued thereunder would be required to be separately passed or undertaken by the Amalgamated Company.

15 DISCHARGE OF CONSIDERATION

15.1 Upon Part B of the Scheme coming into effect on the Effective Date, and upon the amalgamation of the Amalgamating Company No. 1 into and with the Amalgamated Company, the Board of Directors (including any committee thereof) of the Amalgamated Company shall determine a record date, being a date on the filing of the order of the Court sanctioning the Scheme with the RoC (“**Part B Record Date**”), for the allotment of the equity shares of the Amalgamated Company having face value of Rs. 2 each to the shareholders of the Amalgamating Company No. 1 as on the Part B Record Date, in consideration for the amalgamation of the Amalgamating Company No. 1 with and into the Amalgamated Company.

15.2 Based on (i) the valuation report issued by Niranjjan Kumar, a registered valuer, dated December 29, 2020, appointed by both, the Amalgamating Company No. 1 and the Amalgamated Company; and (ii) the fairness opinion issued by SBI Capital Markets Limited, an independent SEBI registered merchant banker on such valuation, dated December 29, 2020, appointed by both, the Amalgamating Company No. 1 and the Amalgamated Company, the Board of directors have determined the following share exchange ratio:

“195 (One hundred ninety-five) fully paid up equity shares of face value of Rs. 2 each of the Amalgamated Company shall be issued and allotted as fully paid up equity shares to the equity shareholders of the Amalgamating Company No. 1, for every 100 (One hundred) fully paid up equity shares of face value of Rs. 2 each held by them in the Amalgamating Company No. 1.”

“195 (One hundred ninety-five) GDS of Amalgamated Company shall be issued for every 100 (One hundred) GDS held in Amalgamating Company No. 1.”

15.3 Any fractional entitlement of shares arising out of the aforesaid share exchange process, if any, will be rounded off to the nearest higher integer.

15.4 In the event of any increase in the issued, subscribed or paid up share capital of the Amalgamating Company No. 1 or the Amalgamated Company or issuance of any instruments convertible into equity shares or restructuring of its equity share capital including by way of share split/consolidation/issue of bonus shares, free distribution of shares or instruments convertible into equity shares or other similar action in relation to share capital of the Amalgamating Company No. 1 or the Amalgamated Company at any time as of the Part B Record Date, except on account of exercise of the Warrants already issued by the Amalgamated Company, the share exchange ratio shall be adjusted appropriately to take into account the effect of such issuance or corporate actions and assuming conversion of any such issued instruments convertible into equity shares.

15.5 The new equity shares of the Amalgamated Company issued as per this Clause shall be subject to the Memorandum and Articles of Association of Amalgamated Company and shall rank *pari passu* in all respects, including dividend and voting rights, with the existing equity shares of the

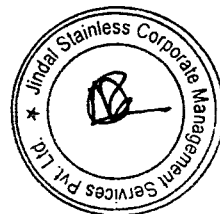
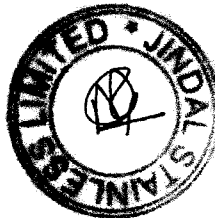
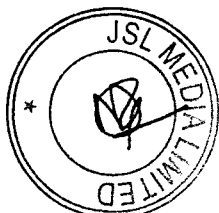
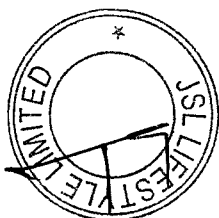
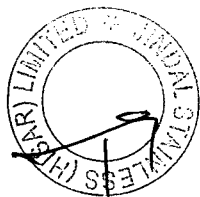
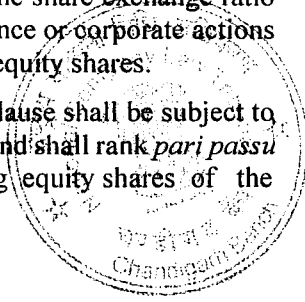

Amalgamated Company.

- 15.6 The issue and allotment of new equity shares by Amalgamated Company to the shareholders of the Amalgamating Company No. 1 as provided in this Part B of the Scheme is an integral part thereof and shall be deemed to have been carried out in full compliance with all the procedures laid down under Section 62 read with Section 42 of the Act and any other applicable provisions of the Act and the rules and regulations issued thereunder.
- 15.7 In accordance with the regulatory requirements, all new equity shares required to be issued by the Amalgamated Company to the shareholders of the Amalgamating Company No. 1 shall be issued in dematerialized form and shall be credited to the depository account of the equity shareholders of the Amalgamating Company No. 1 to the extent the details of such depository participant accounts have been provided to/are available with the Amalgamating Company No. 1 before the Part B Record Date.
- 15.8 For the purpose of allotment of equity shares of Amalgamated Company pursuant to the above sub-Clause 15.2 of Part B of the Scheme, in case any shareholder of the Amalgamating Company No. 1 on the Part B Record Date holds equity shares in the Amalgamating Company No. 1 in physical form and/or details of the depository participant account of such shareholder have not been provided to the Amalgamating Company No. 1 before the Part B Record Date, the Amalgamated Company shall not issue its equity shares to such shareholder but shall subject to Applicable Laws, issue the corresponding number of equity shares in dematerialised form, to a demat account held by a trustee nominated by the Board of Directors of Amalgamated Company or into a suspense account opened in the name of the Amalgamated Company with a depository participant or into an escrow account opened by the Amalgamated Company with a depository, as determined by the Board of the Amalgamated Company. The equity shares of the Amalgamated Company so held in a trustee's account or suspense account or escrow account, as the case may be, shall be transferred to the respective shareholder as per his entitlement once such shareholder provides details of his / her / its depository participant account to the Amalgamated Company in accordance with Applicable Laws, along with such documents as maybe required under Applicable Laws.
- 15.9 In terms of the provisions of the SEBI (Listing Obligations and Disclosure Requirements) Regulations, 2015, relevant listing agreement, SEBI Circular and other Applicable Laws, if any, in each case, as amended, new equity shares to be issued by the Amalgamated Company to the Shareholders of the Amalgamating Company No. 1, pursuant to this Scheme, shall be listed on all the Stock Exchanges on which the equity shares of the Amalgamated Company are listed as on the Effective Date. The Amalgamated Company will make necessary application(s) to the designated stock exchange and other competent authorities, if any, for this purpose and will comply with the provisions of all Applicable Laws in this regard.
- 15.10 Shares allotted pursuant to this Scheme may remain frozen in the Depositories system till listing/trading permission is given by the Stock Exchanges.
- 15.11 The Board of Directors (including any committee thereof) of Amalgamating Company No. 1 and the Amalgamated Company shall be empowered to remove such difficulties as may arise in the course of implementation of this Scheme and registration of new shareholders in the Amalgamated Company on account of the difficulties if any in the transition period.
- 15.12 In addition to the above, subject to the terms of the deposit agreements executed by the Amalgamating Company No. 1 and the Amalgamated Company with their respective Depositories as mentioned in Clause 5.3 and Clause 5.6 above and Applicable Laws including any applicable regulations of the LuxSE, holders of the Amalgamating Company No. 1 GDSs who continue to hold the Amalgamating Company No. 1 GDSs as on the Part B Record Date will be issued Amalgamated Company GDSs in the share exchange ratio in lieu of the Amalgamating Company No. 1 GDSs held by them as mentioned in Clause 15.2 above. The Amalgamated Company shall, and shall cause, all other persons, to take all such actions as may be necessary to issue, allot and list the said Amalgamated Company GDSs issued to the holders of the

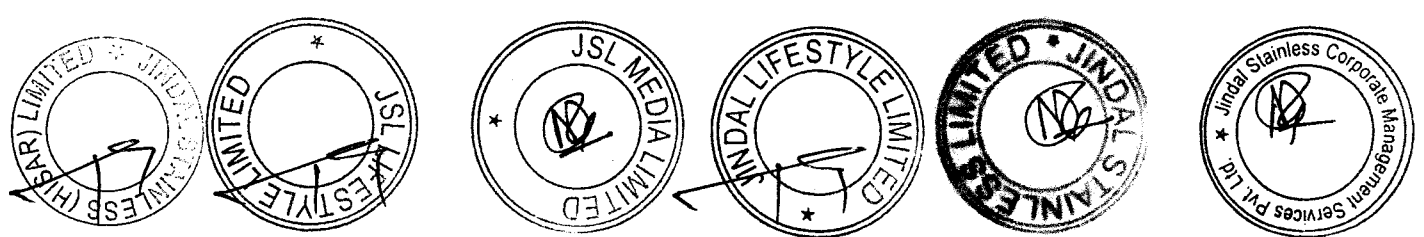
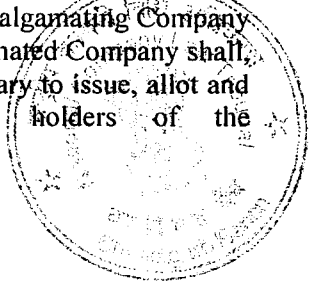

Amalgamating Company No. 1 GDSs on the LuxSE in accordance with Applicable Laws and shall take all such steps and do all such acts, deeds and things as may be necessary for this purpose.

16 CANCELLATION OF SHARES

- 16.1 Upon Part B of the Scheme coming into effect on the Effective Date, all the equity shares held by the Amalgamating Company No. 1 in the share capital of the Amalgamated Company, shall stand automatically cancelled and extinguished, without any further act or deed. Accordingly, the share capital of the Amalgamated Company shall stand reduced to the extent of the face value of the equity shares held by the Amalgamating Company No. 1 and cancelled pursuant to this Clause and the related balance in the securities premium account, if any, shall also stand cancelled pursuant to this Clause.
- 16.2 The reduction of the share capital (including the securities premium account, if any) of the Amalgamated Company as contemplated in this Part B of the Scheme, shall be effected as an integral part of this Scheme in accordance with the provisions provided under Section 230 and any other applicable provisions of the Act. The order of the Court sanctioning this Scheme shall also include approval and confirmation on the reduction of the share capital of the Amalgamated Company, and shall be deemed to be an order under Section 66 read with Section 52 of the Act, as applicable, confirming the reduction and no separate application or sanction shall be necessary for the purposes of such reduction.
- 16.3 The reduction of the share capital, as contemplated above, would not involve either a diminution of liability in respect of unpaid share capital, if any or payment to any shareholder of any unpaid share capital.
- 16.4 The Amalgamated Company shall not be required to add the words "and reduced" as a suffix to its name consequent upon such reduction.

17 DISSOLUTION OF AMALGAMATING COMPANY NO. 1

Upon Part B of this Scheme becoming effective on the Effective Date, Amalgamating Company No. 1 shall stand automatically dissolved as an integral part of this Scheme, without being liquidated or wound-up and without requiring any further act, instrument or deed from the Amalgamating Company No. 1 and/or the Amalgamated Company.

18 ACCOUNTING TREATMENT

Upon Part B of the Scheme becoming effective, with effect from the Appointed Date, the Amalgamated Company shall account for the amalgamation in its books of accounts, as per 'Acquisition Method' in accordance with accounting principles as laid down in Ind AS-103 notified under Section 133 of the Act and under the Companies (Indian Accounting Standards) Rules, 2015, as may be amended from time to time, such that:

- (i) In line with the recognition principles provided under Indian Accounting Standard 103 on Business Combinations, the Amalgamated Company shall recognise all assets and liabilities of the Amalgamating Company No. 1 transferred to and vested in the Amalgamated Company pursuant to Part B of this Scheme at their respective fair values as on the Appointed Date. Such assets may also include acquired identifiable intangible assets, whether previously recorded in the books of accounts of the Amalgamating Company No. 1 or not. Upon Part B of the Scheme coming into effect, the above recognition shall result in the Amalgamated Company recording all the assets and liabilities of the Amalgamating Company No. 1 transferred to and vested in it pursuant to this Scheme.

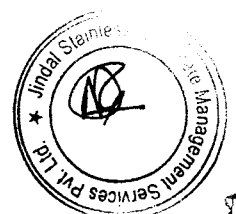
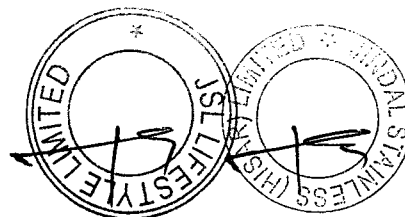
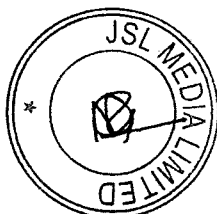
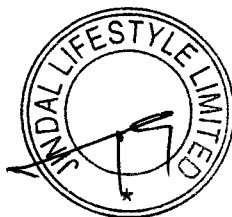
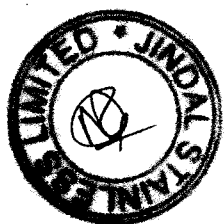
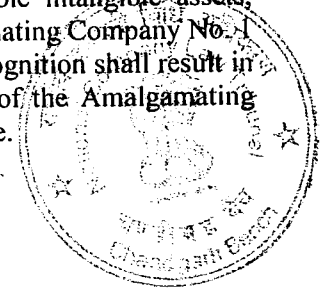

- (ii) The Amalgamated Company shall record issuance of the new equity shares at fair value and accordingly credit to its share capital account the aggregate face value of the new equity shares issued by the Amalgamated Company. The excess of the fair value of the new equity shares over the face value of new equity shares issued by the Amalgamated Company in accordance with Clause 15 shall be credited to the securities premium account.
- (iii) Inter-company balances between the Amalgamated Company and the Amalgamating Company No. 1, if any, shall stand cancelled and there shall be no further obligation in that behalf.
- (iv) Investments held by the Amalgamating Company No. 1 in the Amalgamated Company shall stand cancelled pursuant to the amalgamation and the investment value as appearing in the books of the Amalgamating Company No. 1 shall be reduced from the equity share capital of the Amalgamated Company to the extent of face value of equity shares of the Amalgamated Company held by the Amalgamating Company No. 1 and securities premium account.
- (v) Excess, if any, of fair value of new equity shares issued as per sub-Clause (ii) above over the fair value of net assets taken over as per sub-Clause (i) above, after giving the effect to sub-Clause (iii) and sub-Clause (iv) above, shall be recorded as goodwill. In case of deficit, it shall be credited to capital reserve account.

PART C
DEMERGER OF THE DEMERGED UNDERTAKING AND VESTING OF THE SAME INTO AND WITH THE RESULTING COMPANY

19 DEMERGER OF THE DEMERGED UNDERTAKING OF THE DEMERGED COMPANY AND VESTING OF THE SAME WITH THE RESULTING COMPANY

- 19.1 Subject to the provisions of Part C and Part G of this Scheme in relation to the modalities of the demerger of the Demerged Undertaking of the Demerged Company and vesting of the same with the Resulting Company, upon Part C of this Scheme becoming effective on the Effective Date and with effect from the Appointed Date, immediately after giving effect to Part B of this Scheme, the Demerged Undertaking together with all its assets, liabilities, rights and obligations, properties, benefits and interests therein, shall by virtue of this Part C of this Scheme demerge from the Demerged Company and be, transferred to, and stand vested in, the Resulting Company, and shall become the assets, liabilities, rights, obligations, business and undertaking of the Resulting Company, subject to the existing encumbrances thereon in favour of banks and financial institutions, if any (unless otherwise agreed to by such encumbrance holders), without any further act, instrument or deed being required from the Demerged Company and/or the Resulting Company and without any approval or acknowledgement of any third party, in accordance with Sections 230 to 232 of the Act read with Section 2(19AA) of the IT Act and all other applicable provisions of Applicable Law if any, in accordance with the provisions contained herein.
- 19.2 Without prejudice to the generality of the above, in particular, the Demerged Undertaking shall be demerged from the Demerged Company and transferred and vested in the Resulting Company, in the manner described in the sub-paragraphs below, subject to the existing encumbrances in favour of banks and financial institutions, if any (unless otherwise agreed to by such encumbrance holders): -

- (i) Upon Part C of this Scheme becoming effective on the Effective Date and with effect from the Appointed Date, immediately after giving effect to Part B of this Scheme, all the assets (including investments) forming part of the Demerged Undertaking,

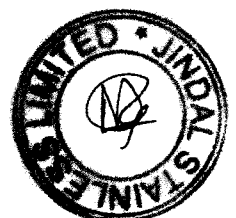
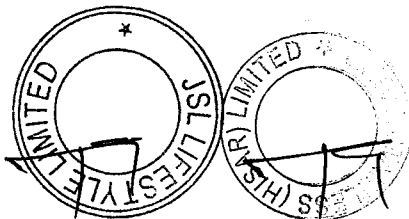
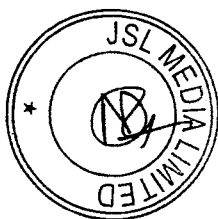
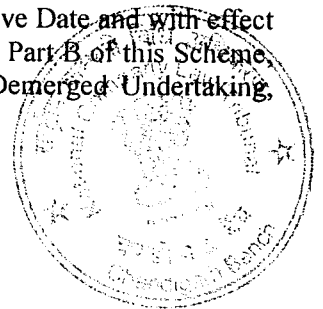
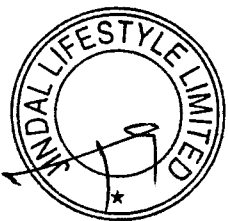

that are movable in nature or incorporeal or intangible in nature or are otherwise capable of transfer by physical or constructive delivery and/or by endorsement and delivery or by transfer or by delivery instructions in relation to dematerialized shares or by vesting and recordal pursuant to the Scheme, including plant, machinery and equipment, shall stand transferred to and vested in and/or be deemed to be transferred to and vested in the Resulting Company and shall become the property and an integral part of the Resulting Company, without any further act, instrument or deed required by either of the Demerged Company and/or the Resulting Company and without any approval or acknowledgement of any third party. The transfer and vesting of the movable assets forming part of the Demerged Undertaking, pursuant to this sub-clause shall be deemed to have occurred by physical or constructive delivery or by endorsement and delivery or by delivery instructions in relation to dematerialized shares or by vesting and recordal, pursuant to this Part C of this Scheme, as appropriate to the property being transferred and vested and the title to such property shall be deemed to have been transferred and vested accordingly.

(ii) Upon Part C of this Scheme becoming effective on the Effective Date and with effect from the Appointed Date, immediately after giving effect to Part B of this Scheme, all other movable properties (except those specified elsewhere in this Clause) forming part of the Demerged Undertaking, including cash and cash equivalents, sundry debts and receivables (including inter-unit receivables, if any, between the undertaking of the Demerged Company engaged in the Non-Mobility Business and the undertaking of the Demerged Company engaged in the Mobility Business), outstanding loans and advances, if any, recoverable in cash or in kind or for value to be received, actionable claims, bank balances and deposits, if any, with any person or body including without limitation any government, semi-government, local and other authorities and bodies, customers and other persons shall, without any further act, instrument or deed required by either of the Demerged Company or the Resulting Company and without any approval or acknowledgement of any third party, become vested in, and shall become the property of, the Resulting Company.

(iii) Upon Part C of this Scheme becoming effective on the Effective Date and with effect from the Appointed Date, immediately after giving effect to Part B of this Scheme, all immovable properties forming part of the Demerged Undertaking, including without limitation, all land together with all buildings and structures standing thereon and all rights and interests therein at Rohad, whether freehold or leasehold or otherwise and all documents of title, rights and easements in relation thereto, shall stand transferred and be vested in and/or be deemed to have been transferred vested in the Resulting Company and shall become the property and an integral part of the Resulting Company, without any further act, instrument or deed being required from the Demerged Company and/or the Resulting Company and without any approval or acknowledgement of any third party. Upon Part C of the Scheme becoming effective on the Effective Date, the Resulting Company shall be entitled to exercise all rights and privileges attached to the aforesaid immovable properties and shall be liable to pay all rent, charges and taxes and fulfil all obligations in relation to or applicable to such immovable properties. The Resulting Company shall be entitled to seek mutation/substitution of title in its name in such immovable properties, for the purposes of information and record and such mutation / substitution of the title to and interest in such immovable properties shall be made and duly recorded in the name of the Resulting Company, by the appropriate authorities pursuant to the sanction of the Scheme by the Court and Part C of the Scheme becoming effective on the Effective Date, in accordance with the terms hereof. However, it is hereby clarified that the absence of any such mutation/substitution shall not adversely affect the rights, title or interest of the Resulting Company in such immovable properties which shall be deemed to have been transferred to the Resulting Company automatically upon the Part C of the Scheme becoming effective on the Effective Date. The

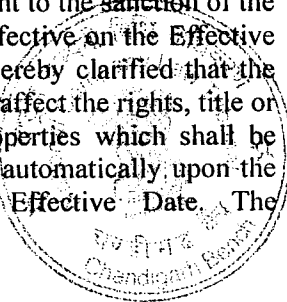
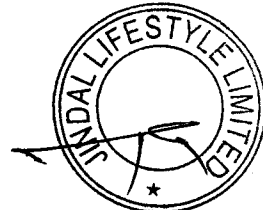
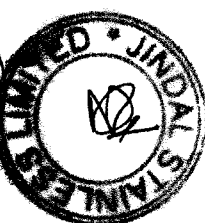
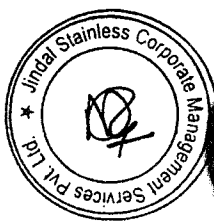
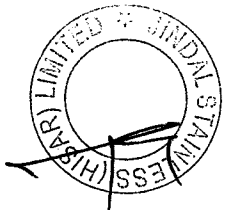
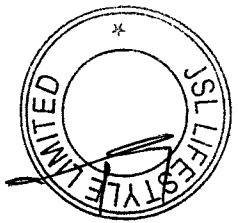
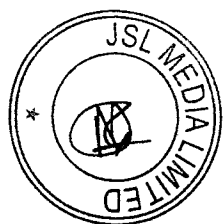

Demerged Company shall take all steps as may be necessary to ensure that lawful and peaceful possession, right, title, interest of such immovable properties of the Demerged Undertaking is given to the Resulting Company in accordance with the terms hereof.

- (iv) Upon Part C of this Scheme becoming effective on the Effective Date and with effect from the Appointed Date, immediately after giving effect to Part B of this Scheme, all debts, liabilities, contingent liabilities, duties and obligations, secured or unsecured, forming part of the Demerged Undertaking (including inter-unit payables, if any, between the undertaking of the Demerged Company engaged in the Non-Mobility Business and the undertaking of the Demerged Company engaged in the Mobility Business), whether provided for or not in the books of accounts of the Demerged Company or disclosed in the balance sheet of the Demerged Company, including general and multipurpose borrowings, if any, dealt with in accordance with Section 2(19AA) of the IT Act, shall become and be deemed to be, the debts, liabilities, contingent liabilities, duties and obligations of the Resulting Company, without any further act, instrument or deed being required from the Demerged Company and/or the Resulting Company and without any approval or acknowledgement of any third party. The Resulting Company undertakes to meet, discharge and satisfy the same in terms of their respective terms and conditions, if any. It is hereby clarified that it shall not be necessary to obtain the consent of any third party or other person, who is a party to any contract or arrangement by virtue of which such debts, liabilities, duties and obligations have arisen in order to give effect to the provisions of this sub-clause. However, the Demerged Company and the Resulting Company shall, if required, file appropriate forms with the RoC accompanied by the sanction order of the Court or a certified copy thereof and execute necessary deeds or documents in relation to creation / satisfaction / modification of charges to the satisfaction of the lenders, in relation to the assets being transferred to the Resulting Company as part of the Demerged Undertaking and/or in relation to the assets remaining in the Demerged Company after the demerger and vesting of the Demerged Undertaking in the Resulting Company pursuant to Part C of this Scheme becoming effective in accordance with the terms hereof. The Resulting Company shall be entitled to take the benefit of all duties and charges already paid by the Demerged Company for the creation/modification of any such security interest. Where any of the loans, liabilities and obligations attributed to the Demerged Undertaking have been discharged by the Demerged Company after the Appointed Date but before the Effective Date, such discharge shall be deemed to have been done by the Demerged Company on behalf of the Resulting Company.
- (v) Upon Part C of this Scheme coming into effect on the Effective Date and with effect from the Appointed Date immediately after giving effect to Part B of this Scheme, all incorporeal or intangible property of or in relation to the Demerged Undertaking shall stand transferred to and vested in the Resulting Company, and shall become the property and an integral part of the Resulting Company without any further act, instrument or deed required by either the Demerged Company and/or the Resulting Company and without any approval or acknowledgement of any third party.
- (vi) Upon Part C of this Scheme coming into effect on the Effective Date and with effect from the Appointed Date, immediately after giving effect to Part B of this Scheme, all letters of intent, memoranda of understanding, memoranda of agreements, tenders, bids, letters of award, expressions of interest, experience and/or performance statements, contracts, deeds, bonds, agreements, guarantees and indemnities, schemes, arrangements, undertakings and other instruments of every nature and description including without limitation, those relating to tenancies, privileges, powers and facilities of every kind and description pertaining to the Demerged Undertaking, to which the Demerged Company is a party or to the benefit of which

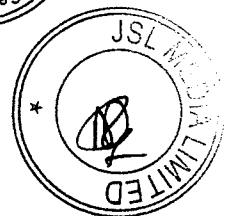
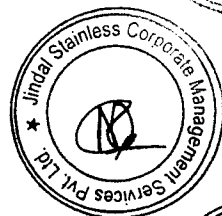
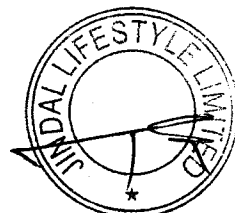
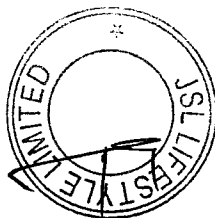

the Demerged Company may be eligible or under which the Demerged Company is an obligor (except to the extent provided in this Clause) and which are subsisting or having effect immediately prior to Part C of the Scheme coming into effect on the Effective Date, shall be and shall remain in full force and effect against or in favour of the Resulting Company and may be enforced by or against it as fully and effectually as if, instead of the Demerged Company, the Resulting Company had been a party or beneficiary or obligee or obligor thereto, without any further act, instrument or deed being required from the Demerged Company and/or the Resulting Company and without any approval or acknowledgement of any third party.

- (vii) Upon Part C of the Scheme coming into effect on the Effective Date and with effect from the Appointed Date, immediately after giving effect to Part B of this Scheme, all statutory or regulatory licenses and permits, grants, allotments, recommendations, no-objection certificates, permissions, registrations, approvals, certificates, consents, quotas, exemptions, clearances (including environmental approvals and consents), tenancies, privileges, powers, offices, facilities, entitlements or rights (including licenses issued by the DGFT under EPCG Scheme, Advance Authorization Scheme, Focused Products Scheme, Focused Marketing Scheme, Duty Drawback Scheme and other schemes or approvals of a like nature issued by the DGFT) granted/available/renewed/applied for, to or by the Demerged Company in relation to the Demerged Undertaking shall stand transferred to and vested in the Resulting Company, without any further act, instrument or deed being required by the Demerged Company and/or the Resulting Company and without any approval or acknowledgement of any third party. Upon Part C of the Scheme coming into effect on the Effective Date, the Resulting Company shall be entitled to all the benefits thereof and shall be liable for all the obligations thereunder. In relation to the same, any procedural requirements required to be fulfilled solely by Demerged Company (and not by any of their successors), shall be fulfilled by the Resulting Company as if it is the duly constituted attorney of the Demerged Company. It is hereby clarified that if the consent or approval (by whatever name called) of any third party or authority is required to give effect to the provisions of this Clause, the said third party or authority shall duly record or provide such consent or approval and shall make the necessary substitution/endorsement in the name of the Resulting Company pursuant to the sanction of this Scheme by the Court, and upon Part C of this Scheme becoming effective in accordance with the terms hereof. For this purpose, the Resulting Company may file appropriate applications/documents with relevant authorities concerned for information and record purposes. However, it is hereby clarified that the absence of any such substitution/endorsement shall not adversely affect the rights, benefits or interest of the Resulting Company which shall be deemed to have been transferred to the Resulting Company automatically upon the Part C of the Scheme becoming effective on the Effective Date.
- (viii) Upon Part C of the Scheme coming into effect on the Effective Date and with effect from the Appointed Date, immediately after giving effect to Part B of this Scheme, all workmen and employees forming part of the Demerged Undertaking, who are on the payrolls of the Demerged Company and all other personnel employed by the Demerged Company who form part of the Demerged Undertaking shall become employed by the Resulting Company with effect from the Effective Date, on such terms and conditions as are no less favourable than those on which they were engaged with the Demerged Company immediately prior to the Effective Date, without any interruption of service as a result of this demerger and transfer. With regard to provident fund, gratuity fund, superannuation fund and any contributions required to be made in relation to employees under any statute or regulation, leave encashment and any other special scheme or benefits created or existing for the benefit of the personnel employed by the Demerged Company immediately prior to Part C of the Scheme coming into effect on the Effective Date and transferred to the

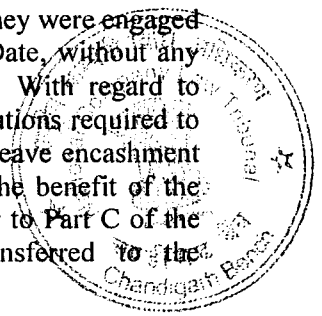
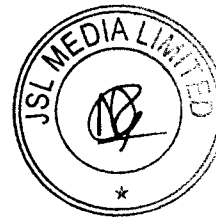
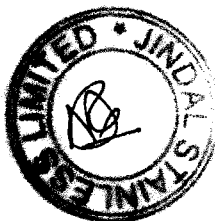
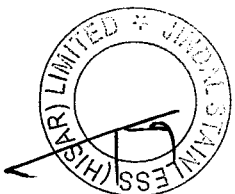

Resulting Company, the Resulting Company shall stand substituted for the Demerger Company for all intents and purposes whatsoever, upon Part C of this Scheme becoming effective on the Effective Date, including with regard to the obligation to make contributions to the said funds in accordance with the provisions of such schemes or funds in the respective trust deeds or other documents and/or in accordance with the provisions of Applicable Laws or otherwise. All existing contributions made to such schemes and funds and all benefits accrued thereto shall also stand transferred in the name of the Resulting Company and all such benefits and schemes shall be continued by the Resulting Company for the benefit of such personnel employed by the Demerged Company in relation to the Demerged Undertaking and transferred to the Resulting Company, on the same terms and conditions. Further, it is the aim and intent of the Scheme that all the rights, duties, powers and obligations of the Demerger Company in relation to such schemes or funds in relation to the employees and workmen forming part of the Demerged Undertaking shall become those of the Resulting Company. It is clarified that the services of all personnel employed by Demerged Company in the Demerged Undertaking, who are entitled to the benefits under such schemes and funds, will be treated as having been continuous and uninterrupted for the purpose of the aforesaid schemes or funds.

- (ix) Upon Part C of the Scheme coming into effect on the Effective Date immediately after giving effect to Part B of this Scheme, the Resulting Company undertakes to continue to abide by any agreement(s)/settlement(s) entered into with any labour unions/employees of the Demerged Undertaking by the Demerged Company. The Resulting Company agrees that for the purpose of payment of any future retrenchment compensation, gratuity and other terminal benefits, the past services of such employees of the Demerged Undertaking, if any, with the Demerged Company, as the case may be, shall also be taken into account, and agrees and undertakes to pay the same as and when payable. Further, upon Part C of the Scheme coming into effect on the Effective Date, any prosecution or disciplinary action initiated, pending or contemplated against and any penalty imposed in this regard on any employee of the Demerged Undertaking by the Demerged Company shall be continued or shall continue to operate against the relevant employee and shall be enforced effectively by the Resulting Company.
- (x) Upon Part C of the Scheme coming into effect on the Effective Date and with effect from the Appointed Date, immediately after giving effect to Part B of this Scheme, all rights, entitlements, licenses, applications and registrations relating to trademarks, service marks, copyrights, domain names, brand name, logos, patents and other intellectual property rights of every kind and description, including without limitations, all rights whether registered, unregistered or pending registration, and the goodwill arising therefrom, if any, to which the Demerged Company is a party or to the benefit of which the Demerged Company may be eligible or entitled, and in each case which form part of the Demerged Undertaking, shall stand transferred to and vested in the Resulting Company, and shall become the rights, entitlement or property of the Resulting Company and shall be enforceable by or against the Resulting Company, as fully and effectually as if, instead of the Demerged Company, the Resulting Company had been a party or beneficiary or obligee thereto or the holder or owner thereof, without any further act, instrument or deed required by either of the Demerged Company or the Resulting Company and without any approval or acknowledgement of any third party.
- (xi) Upon Part C of the Scheme coming into effect on the Effective Date and with effect from the Appointed Date, immediately after giving effect to Part B of this Scheme, the Resulting Company shall be entitled to the benefit of all insurance policies (if any) which have been issued in respect of Demerged Undertaking and/or any of its

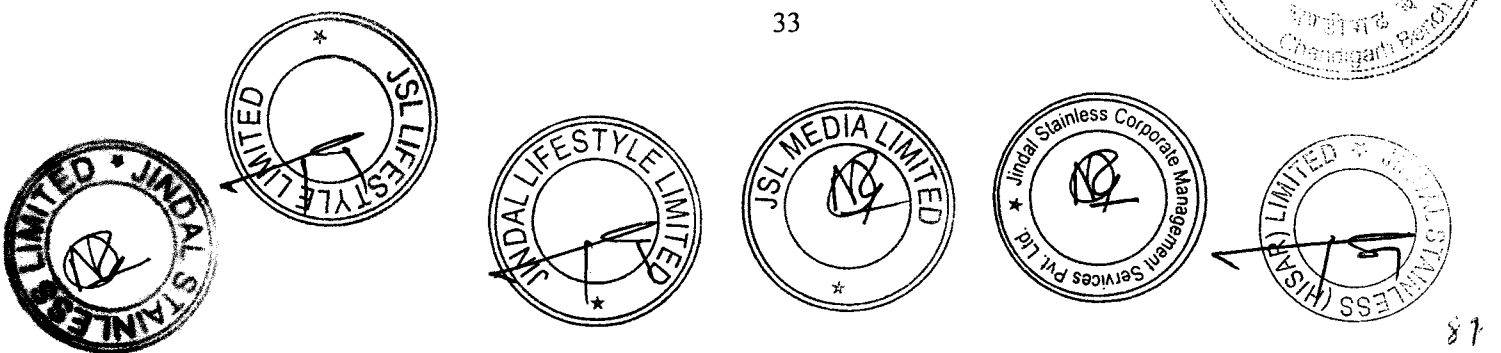

assets or employees and the name of the Resulting Company shall stand substituted as the "Insured" in all such policies as if the Resulting Company was originally a party thereto without any further act, instrument or deed required by either of the Demerged Company or the Resulting Company and without any approval or acknowledgement of any third party. Further, the Resulting Company shall be entitled to the benefit of all claims filed, prosecuted, proposed to be filed, pending and/or adjudicated in relation to all insurance policies issued in respect of Demerged Undertaking and/or any of its assets or employees.

- (xii) Upon Part C of the Scheme coming into effect on the Effective Date and with effect from the Appointed Date, immediately after giving effect to Part B of this Scheme, all taxes and duties of whatsoever description (including but not limited to all carry forward tax losses comprising of unabsorbed depreciation, advance tax payments, TDS, TCS, MAT, securities transaction tax, taxes withheld/paid in a foreign country, customs duty, entry tax, value added tax, GST, sales tax, service tax etc.) payable by or refundable to the Demerged Company in relation to the Demerged Undertaking, including all or any refunds or claims in relation thereto (including unutilized input credits of the Demerged Undertaking) shall be treated as the tax liability or refunds/claims, as the case may be, of the Resulting Company, and any tax incentives, advantages, privileges, exemptions, credits, holidays, remissions, reductions etc., as would have been available to the Demerged Company in relation to the Demerged Undertaking, shall pursuant to this Scheme becoming effective, be available to the Resulting Company without any further act, instrument or deed required by either of the Demerged Company or the Resulting Company and without any approval or acknowledgement of any third party but in the manner more particularly set out herein below. Upon Part C of the Scheme coming into effect on the Effective Date and with effect from the Appointed Date, immediately after giving effect to Part B of the Scheme, all existing and future incentives, un-availed credits and exemptions, benefit of carried forward losses and other statutory benefits, including in respect of income tax (including MAT), excise (including Modvat/ Cenvat), customs, value added tax, sales tax, service tax to which the Demerged Company is entitled in relation to the Demerged Undertaking shall be available to and shall stand transferred and vested in the Resulting Company without any further act, instrument or deed required by either the Resulting Company or the Demerged Company and without any approval or acknowledgement of any third party. Upon Part C of the Scheme coming into effect on the Effective Date and with effect from the Appointed Date, immediately after giving effect to Part B of the Scheme, any tax deducted at source deducted by or on behalf of the Demerged Company until the Effective Date shall be deemed to have been deducted on behalf of the Resulting Company to the extent of the income attributable to the Demerged Undertaking during such period.
- (xiii) Upon Part C of the Scheme coming into effect on the Effective Date and with effect from the Appointed Date, immediately after giving effect to Part B of this Scheme, the Resulting Company shall be entitled to claim the benefit of any and all corporate approvals and limits as may have already been taken by the Demerged Company in relation to the Demerged Undertaking, including without limitation, the approvals and limits under Sections 62, 179, 180, 185, 186, 188 etc., of the Act, until the time the same are duly modified by the Resulting Company.
- (xiv) Upon Part C of the Scheme coming into effect on the Effective Date and with effect from the Appointed Date, immediately after giving effect to Part B of this Scheme, all other estates, assets, rights, title, interests and authorities accrued to and/or acquired by the Demerged Undertaking or by the Demerged Company in relation to the Demerged Undertaking shall be deemed to have been accrued to and/or acquired for and on behalf of the Resulting Company and shall, upon Part C of this Scheme

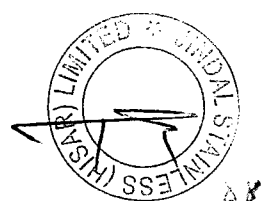
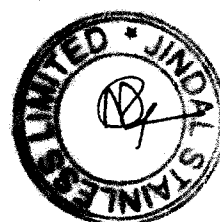
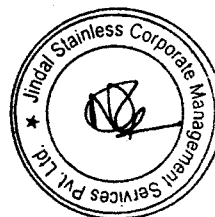
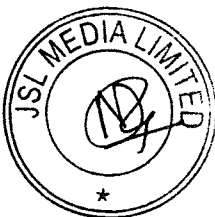
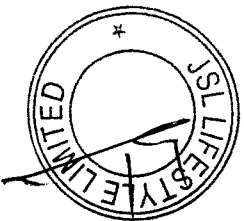

coming into effect, pursuant to the provisions of the Act, without any further act, instrument or deed be and stand transferred to or vested in and/or be deemed to have been transferred to or vested in the Resulting Company to that extent and shall become the estates, assets, right, title, interests and authorities of the Resulting Company.

- (xv) Upon Part C of the Scheme coming into effect on the Effective Date immediately after giving effect to Part B of this Scheme, all books, record files, papers, computer programs, engineering and process information, manuals, data, production methodologies, production plans, designs, catalogues, quotations, websites, cloud storage, sales and advertising material, marketing strategies, list of present and former customers, customer credit information, customer pricing information, and other records whether in physical form or electronic form or in any other form in connection with or relating to the Demerged Company pertaining to the Demerged Undertaking shall be deemed to have been transferred to or acquired for and on behalf of the Resulting Company and shall, upon Part C of this Scheme coming into effect immediately after giving effect to Part B of this Scheme, without any further act, instrument or deed be and stand transferred to or vested in and/or be deemed to have been transferred to or vested in the Resulting Company.
- (xvi) Upon Part C of the Scheme coming into effect on the Effective Date and with effect from the Appointed Date, immediately after giving effect to Part B of this Scheme, the Resulting Company shall bear the burden and the benefits of any legal, tax, quasi-judicial, administrative, regulatory or other proceedings initiated by or against the Demerged Company in relation to the Demerged Undertaking. If any suit, appeal or other proceeding of whatsoever nature by or against the Demerged Company, in relation to the Demerged Undertaking, shall be pending as on the Effective Date, the same shall not abate, be discontinued or in any way be prejudicially affected by reason of the demerger of such Demerged Undertaking and transfer and vesting of the same in the Resulting Company or of anything contained in Part C of this Scheme but the proceedings may be continued, prosecuted and enforced by or against the Resulting Company in the same manner and to the same extent as it would or might have been continued, prosecuted and enforced by or against the Demerged Company in relation to the Demerged Undertaking as if Part C of this Scheme had not been made effective. Upon Part C of the Scheme becoming effective immediately after giving effect to Part B of this Scheme, the Resulting Company undertakes to have such legal or other proceedings initiated by or against the Demerged Company in relation to the Demerged Undertaking transferred in its name and to have the same continued, prosecuted and enforced by or against the Resulting Company to the exclusion of the Demerged Company. The Resulting Company also undertakes to handle all legal or other proceedings which may be initiated against the Demerged Company in relation to the Demerged Undertaking, after the Effective Date in its own name and account and further undertakes to pay all amounts including interest, penalties, damages etc., pursuant to such legal/ other proceedings.

19.3 Upon Part C of the Scheme coming into effect on the Effective Date with effect from the Appointed Date, immediately after giving effect to Part B of this Scheme, the Resulting Company shall be entitled to the benefit of the past experience, accreditation, and/or performance of the Demerged Undertaking for all purposes without any further act, instrument or deed required by either of the Demerged Company or the Resulting Company and without any approval or acknowledgement being required from any third party. If any instrument or deed or document is required or deemed necessary or expedient to give effect to the provisions of this Clause by the Demerged Company, the Resulting Company shall, under the provisions of Part C of the Scheme, be deemed to be duly authorized to execute all such writings on behalf of the Demerged Company and to carry out or perform all such formalities or compliances referred to

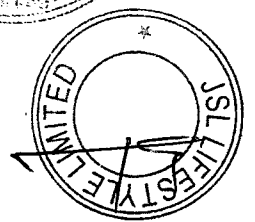
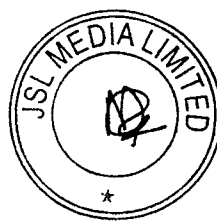
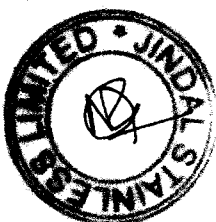
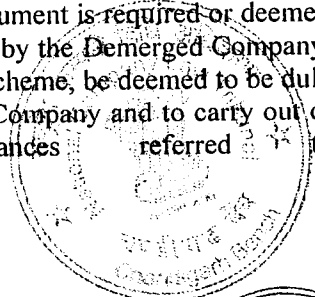
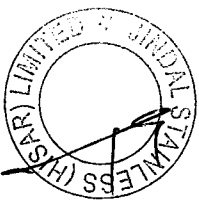

237

above on behalf of the Demerged Company.

20 CONDUCT OF AFFAIRS UNTIL THE EFFECTIVE DATE

- 20.1 In the event Part C becomes effective and with effect from the Appointed Date, immediately after giving effect to Part B of this Scheme, and up to and including the Effective Date:
 - (i) the Demerged Company shall be deemed to have carried on the business activities of the Demerged Undertaking and stand possessed of the properties and assets of the Demerged Undertaking, for, on behalf of and in trust for, the Resulting Company; and
 - (ii) all profits or income accruing to or received by the Demerged Company in relation to the Demerged Undertaking and all taxes paid thereon (including but not limited to advance tax, TDS, TCS, MAT, fringe benefit tax, securities transaction tax, taxes withheld/paid in a foreign country, customs duty, entry tax, value added tax, GST, sales tax, service tax etc.) or losses arising in or incurred by the Demerged Company in relation to the Demerged Undertaking shall, for all purposes, be treated as and deemed to be the profits, income, taxes or losses, as the case may be, of the Resulting Company.
- 20.2 Subject to the provisions of Clause 20.1 hereinabove, in the event any asset, contract, document, liability or property or the rights, interest, obligations and benefits thereof or thereunder (including without limitation, shipping documents, bills of entry, foreign inward remittance certificates and bank realization certificates), which is a part of the Demerged Undertaking does not get automatically transferred to the Resulting Company upon Part C of the Scheme coming into effect on the Effective Date immediately after giving effect to Part B of this Scheme, the Demerged Company shall take all necessary steps and execute all necessary documents, to ensure the transfer of such asset, contract, document, liability and property or the rights, interest, obligations and benefits thereof and thereunder to the Resulting Company forthwith after the Effective Date without any further consideration and until the transfer of any such asset, the Resulting Company will have the right to use the same without payment of any additional consideration. It is clarified that even after Part C of the Scheme comes into effect on the Effective Date, the Demerged Company shall, with the written consent of the Resulting Company, be entitled to realize or pay all monies and to complete, enforce or discharge all pending contracts, arrangements or obligations in relation to the Demerged Undertaking in trust and at the sole cost and expense of the Resulting Company in so far as may be necessary until all rights and obligations of the Demerged Company in respect of such pending contracts, arrangements or obligations stand fully devolved to and in favour of the Resulting Company.
- 20.3 The Resulting Company shall also be entitled, pending the sanction of this Scheme, to apply to the central government, state government, and all other agencies, departments, statutory authorities and Governmental Authorities concerned, wherever necessary, for such consents, approvals and sanctions which the Resulting Company may require including the registration, approvals, exemptions, reliefs, etc., as may be required/granted under any Applicable Law for the time being in force for carrying on the business of the Demerged Undertaking.

21 TREATMENT OF TAXES

- 21.1 Upon this Scheme becoming effective on the Effective Date and with effect from the Appointed Date, immediately after coming into effect of Part B of this Scheme, all taxes and duties payable by the Demerged Company (including under the IT Act, Customs Act, 1962, Central Excise Act, 1944, Integrated Goods and Services Tax Act, 2017 ('IGST'), Central Goods and Services Tax Act, 2017 ('CGST'), Haryana Goods and Services Tax Act, 2017 and any other state Goods and Services Tax Act, 2017 ('SGST'), the Goods and Services Tax (Compensation to States) Act, 2017 and all other Applicable Laws), accruing and/or relating to, the Demerged Undertaking, for any period falling on or after the Appointed Date, including all advance tax payments, TDS, TCS, MAT and all refunds and claims in relation thereto shall, for all purposes, be treated as

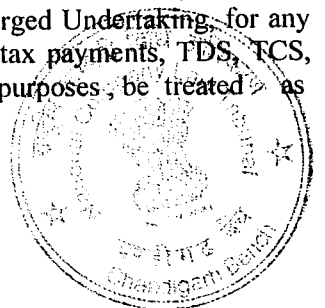
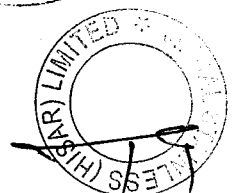
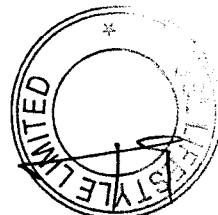
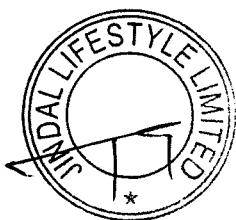

- advance tax payments, TDS, TCS, MAT or refunds and claims, as the case may be, of the Resulting Company.
- 21.2 Upon this Scheme becoming effective on the Effective Date, and with effect from the Appointed Date, immediately after coming into effect of Part B of this Scheme, all unavailed credits and exemptions, benefit of carried forward losses and other statutory benefits, including in respect of income tax (including TDS, TCS, advance tax, MAT credit etc.), CENVAT, customs, IGST, CGST, SGST etc. relating to the Demerged Undertaking to which Demerged Company is entitled / obligated to, shall be available to and vest in the Resulting Company, without any further act, deed or instrument.
 - 21.3 Upon this Scheme becoming effective on the Effective Date, and with effect from the Appointed Date, immediately after coming into effect of Part B of this Scheme, Demerged Company and the Resulting Company shall be permitted to revise and file their respective income tax returns, withholding tax returns, including TDS certificates, TDS returns, GST returns and other tax returns for the period commencing on and from the Appointed Date to give effect to the demerged and transfer of the Demerged Undertaking from the Demerged Company to the Resulting Company and any matters connected therewith, and to claim all refunds, credits, etc., pertaining to the Demerged Undertaking, pursuant to the provisions of this Scheme without any further act, deed or instrument or consent or approval of any third party.
 - 21.4 The Board of Directors of the Demerged Company shall be empowered to determine if any specific tax liability or any tax proceeding relates to the Demerged Undertaking and therefore is required to be transferred to the Resulting Company.
 - 21.5 Upon Part C of the Scheme becoming effective on the Effective Date and with effect from the Appointed Date, immediately after coming into effect of Part B of this Scheme, any TDS deposited, TDS certificates issued or TDS returns filed by the Demerged Company relating to the Demerged Undertaking shall continue to hold good as if such TDS amounts were deposited, TDS certificates were issued, and TDS returns were filed by the Resulting Company.
 - 21.6 All the expenses incurred by Demerged Company and the Resulting Company in relation to Part C of the Scheme, including stamp duty expenses, if any, shall be allowed as deduction to Demerged Company and the Resulting Company in accordance with the Section 35DD of the IT Act over a period of five (5) years beginning with the previous year in which Part C of the Scheme becomes effective.
 - 21.7 Upon Part C of the Scheme becoming effective on the Effective Date and with effect from the Appointed Date, immediately after coming into effect of Part B of this Scheme, any refund under the tax laws due to Demerged Company pertaining to the Demerged Undertaking consequent to the assessments made on Demerged Company and for which no credit is taken in the accounts of the Demerged Company as on the date immediately preceding the Appointed Date shall belong to and be received by the Resulting Company. The relevant Government Authorities shall be bound to transfer to the account of and give credit for the same to, the Resulting Company upon this Part C of the Scheme becoming effective upon relevant proof and documents being provided to the said Governmental Authorities.

22 CONDUCT OF AFFAIRS AFTER THE EFFECTIVE DATE

- 22.1 The Resulting Company, shall, at any time after Part C of this Scheme becomes effective on the Effective Date immediately after giving effect to Part B of this Scheme, in accordance with the provisions hereof, if so required under any law, contract or otherwise, be entitled to do and take all such actions as may be required to give full effect to the provisions of this Part C and for this purpose the Resulting Company shall, under the provisions hereof, be deemed to be authorised on behalf of the Demerged Company. Without prejudice to the generality of the above, the Resulting Company shall be, with respect to the Demerged Undertaking, entitled and deemed to be authorised to:-

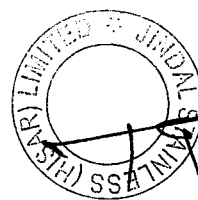
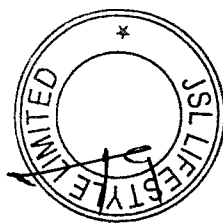
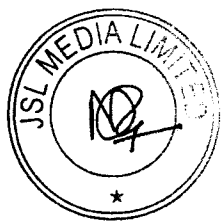
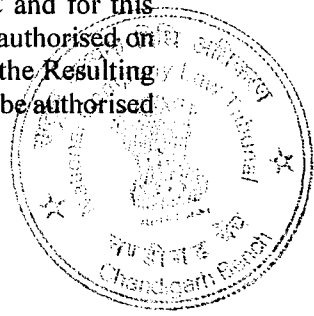
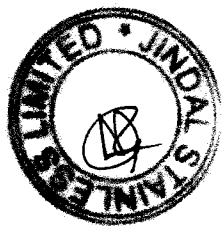

- (i) execute appropriate deeds of confirmation or other writings or arrangements with any party to any contract or arrangement (including without limitation any bank guarantee, performance guarantee, fixed deposit, letters of credit, bill of entry etc.) in relation to the Demerged Undertaking, which the Demerged Company have been a party or to the benefit of which the Demerged Company may have been entitled, and to make any filings with the regulatory authorities, in order to give formal effect to the provisions of Part C of the Scheme; and
- (ii) do all such acts or things as may be necessary to effectually transfer/obtain in favour of the Resulting Company the approvals, consents, bids, awards, tenders, exemptions, registrations, no-objection certificates, permits, quotas, rights, entitlements, licenses and certificates etc. which were held or enjoyed by the Demerged Company in relation the Demerged Undertaking including without limitation, execute all necessary or desirable writings and confirmations on behalf of the Demerged Company and to carry out and perform all such acts, formalities and compliances as may be required in this regard.

22.2 The provisions of this Clause shall operate notwithstanding anything to the contrary contained in any deed or writing or certificate or license or the terms of sanction or issue or any security, all of which instruments and documents shall stand modified and/or superseded by the foregoing provisions.

22.3 This Scheme has been drawn up to comply with the conditions relating to "Demerger" as specified under Section 2(19AA) of the IT Act. If any terms or provisions of this Scheme are found to be or interpreted to be inconsistent with the said provision at a later date whether as a result of a new enactment or any amendment to any existing enactment or the coming into force of any provision of the IT Act or any other law or any judicial or executive interpretation or for any other reason whatsoever, the aforesaid provision shall prevail and this Scheme (including any parts hereof) may be modified to comply with such laws or may be withdrawn at the discretion of the Board of Directors of the Demerged Company and the Resulting Company. Such modification/withdrawal will however not affect other Parts of the Scheme which have not been so modified or withdrawn.

23 SAVING OF CONCLUDED TRANSACTIONS

The transfer of properties and liabilities to, and the continuance of proceedings by or against, Resulting Company as envisaged in this Part C shall not affect any transaction or proceedings already concluded by the Demerged Company in relation to the Demerged Undertaking on or before the Appointed Date and after the Appointed Date and until the Effective Date, and to such end and intent the Resulting Company accepts and adopts all acts, deeds and things done and executed by Demerged Company in respect thereto as done and executed on behalf of itself.

24 DISCHARGE OF CONSIDERATION

24.1 Upon Part C of the Scheme coming into effect on the Effective Date and with effect from the Appointed Date, immediately after giving effect to Part B of this Scheme, in consideration for the demerger of the Demerged Undertaking from the Demerged Company and vesting into and with the Resulting Company, the Board of Directors (including any committee thereof) of the Resulting Company shall determine a record date, being a date on the filing of the order of the Court sanctioning the Scheme with the RoC ("Part C Record Date"), for the allotment of the equity shares of the Resulting Company having face value of Rs. 10 (Rupees Ten) each to the shareholders of the Demerged Company as on the Part C Record Date whose names appear in the Register of Members (or records of the registrar and transfer agent) of the Demerged Company. To the extent the Amalgamating Company No. 1 was a shareholder of the Demerged Company immediately before the Effective Date, upon Part B of this Scheme coming into effect on the

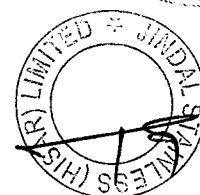
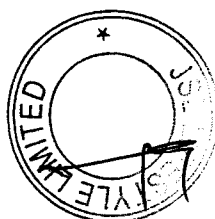
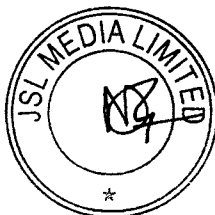
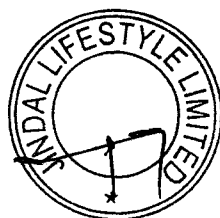
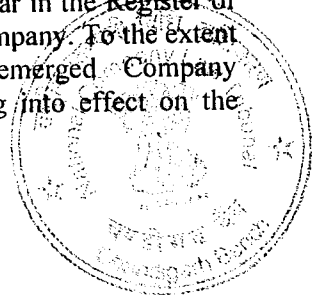
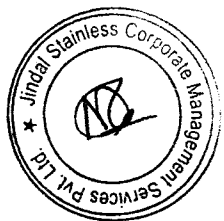

Effective Date with effect from the Appointed Date but before giving effect to this Part C of the Scheme, it shall be deemed that pursuant to the amalgamation of the Amalgamating Company No. 1 with the Amalgamated Company, the Amalgamated Company's name has been substituted in place of the Amalgamating Company No. 1 in the Register of Members (or records of the registrar and transfer agent) of the Demerged Company as on the Part C Record Date. Accordingly, the Resulting Company shall issue to the Amalgamated Company, the equity shares of the Resulting Company which the Amalgamating Company No. 1 would have been entitled to receive on account of its shareholding in Demerged Company immediately before the Effective Date.

24.2 Based on the valuation report issued by Niranjana Kumar, a registered valuer, dated December 29, 2020, appointed by both the Demerged Company and the Resulting Company, the respective Board of Directors of the Demerged Company and the Resulting Company have determined the following share exchange ratio:

"1 (One) fully paid up equity shares of face value of Rs. 10 each of the Resulting Company shall be issued and allotted as fully paid up equity shares to the equity shareholders of the Demerged Company, for every 1 (One) fully paid up equity shares of face value of Rs. 10 each held by them in Demerged Company."

24.3 Any fractional entitlement of shares arising out of the aforesaid share exchange ratio, if any, will be rounded off to the nearest higher integer.

24.4 In the event of any increase in the issued, subscribed or paid up share capital of the Demerged Company or the Resulting Company or issuance of any instruments convertible into equity shares or restructuring of its equity share capital including by way of share split/consolidation/issue of bonus shares, free distribution of shares or instruments convertible into equity shares or other similar actions in relation to share capital of the Demerged Company or the Resulting Company at any time before the Part C Record Date, the share exchange ratio shall be adjusted appropriately to take into account the effect of such issuance or corporate actions and assuming conversion of any such issued instruments convertible into equity shares.

24.5 The new equity shares of the Resulting Company issued as per this Clause shall be subject to the Memorandum and Articles of Association of Resulting Company and shall rank *pari passu* in all respects, including dividend and voting rights, with the existing equity shares of the Resulting Company.

24.6 On the approval of Part C of the Scheme by the members of the Resulting Company pursuant to Sections 230 to 232 of the Act, it shall be deemed that the members of the Resulting Company have also accorded their consent under Sections 42 and 62 of the Act and the applicable rules and regulations issued thereunder for the aforesaid issuance of equity shares of the Resulting Company, to the shareholders of the Demerged Company, and all actions taken in accordance with this Clause of this Scheme shall be deemed to be in full compliance of Sections 42 and 62 of the Act and other applicable provisions of the Act and no further resolution or actions under Sections 42 and 62 of the Act or the rules and regulations issued thereunder, including, *inter alia*, issuance of a letter of offer by the Resulting Company shall be required to be passed or undertaken.

24.7 In accordance with the regulatory requirements, all new equity shares required to be issued by the Resulting Company to the shareholders of the Demerged Company shall be issued in dematerialized form and shall be credited to the depository account of the equity shareholders of the Demerged Company to the extent the details of such depository participant accounts have been provided to/are available with the Demerged Company as of the Part C Record Date.

24.8 For the purpose of allotment of equity shares of Resulting Company pursuant to the above Clause 24.2 of Part C of the Scheme, in case any shareholder of the Demerged Company on the Part C Record Date holds equity shares in the Demerged Company in physical form and/or details of the depository participant account of such shareholder have not been provided to the Demerged Company as of the Part C Record Date, the Resulting Company shall not issue its equity shares

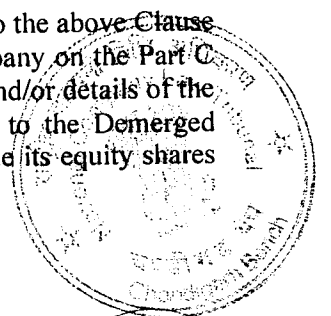
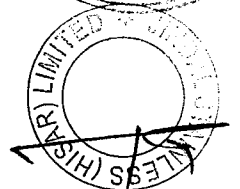
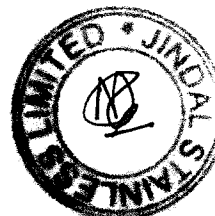
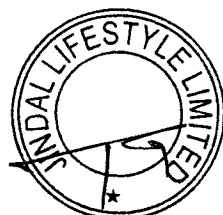
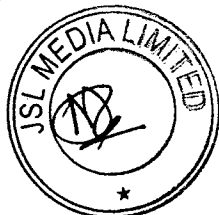
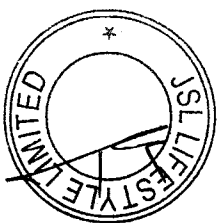

to such shareholder but shall subject to Applicable Laws, issue the corresponding number of equity shares in dematerialised form, to a demat account held by a trustee nominated by the Board of Directors of the Resulting Company or into a suspense account opened in the name of the Resulting Company with a depository participant or into an escrow account opened by the Resulting Company with a depository, as determined by the Board of Directors of the Resulting Company. The equity shares of the Resulting Company so held in a trustee's account or suspense account or escrow account, as the case may be, shall be transferred to the respective shareholder as per his entitlement once such shareholder provides details of his / her / its depository participant account to the Resulting Company in accordance with Applicable Laws, along with such documents as maybe required under Applicable Laws.

25 REDUCTION IN SHARE CAPITAL OF THE RESULTING COMPANY

25.1 Upon Part C of this Scheme becoming effective on the Effective Date immediately after coming into effect of Part B of this Scheme, as an integral part of this Scheme and immediately after issuance of the equity shares of the Resulting Company having face value of Rs. 10 (Rupees Ten) each to the shareholders of the Demerged Company in accordance with Clause 24 above, the equity shares of the Resulting Company held by the Demerged Company, comprising of 100% of the total issued and paid-up equity share capital of the Resulting Company as on the Part C Record Date, shall stand cancelled without any further act or deed on the part of the Resulting Company or the Demerged Company. The reduction in the share capital of the Resulting Company shall be in accordance with Section 66 of the Act and/or any other applicable provisions of the Act without any further act or deed on the part of the Resulting Company and without any approval or acknowledgment of any third party. The order of the Court sanctioning the Scheme shall be deemed to also be the order passed by the Court under Section 66 of the Act, for the purpose of confirming such reduction. The aforesaid reduction would not involve either a diminution of liability in respect of the unpaid share capital or payment of paid-up share capital and the provisions of Section 66(1)(a) of the Act shall not be applicable. Notwithstanding the reduction in the equity share capital of the Resulting Company, the Resulting Company shall not be required to add "And Reduced" as suffix to its name.

25.2 It is expressly clarified that for the purposes of this Clause 25 of Part C of the Scheme, the consent of the shareholders and the creditors of the Resulting Company to the Scheme shall be deemed to be sufficient for the purposes of effecting the above reorganization in the share capital of the Resulting Company resulting in a reduction in the equity share capital of the Resulting Company, and no further resolution or action under Section 66 of the Act and/or any other applicable provisions of the Act would be required to be separately passed or taken.

25.3 Such reduction in the share capital of the Resulting Company as contemplated in this Clause 25 of Part C of the Scheme shall be conditional upon Part B and Part C of this Scheme becoming effective on the Effective Date. If this Scheme is, for any reason whatsoever, not sanctioned by the Court, such reduction of share capital as set out in this Clause 25 of Part C of the Scheme shall not become effective and shall be deemed to be redundant.

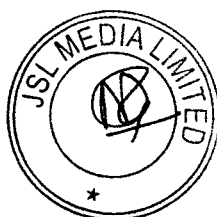
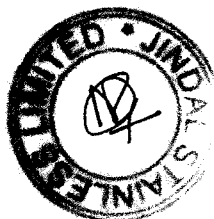
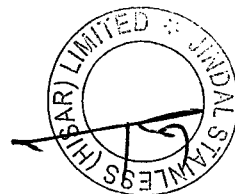
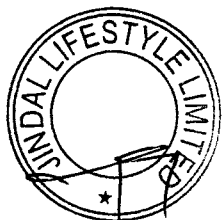
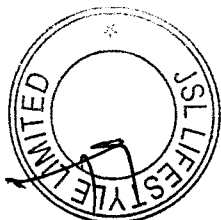

242

26 INCREASE IN THE AUTHORISED SHARE CAPITAL OF THE RESULTING COMPANY

- 26.1 Upon Part C of this Scheme coming into effect on the Effective Date, immediately after giving effect to Part B of this Scheme the authorized share capital of Resulting Company of Rs.50,00,000 (Rupees Fifty Lakhs) divided into 5,00,000 (Five Lakhs) equity shares having face value of Rs. 10 (Rupees Ten) each, in terms of Clause V of its Memorandum of Association shall stand enhanced to Rs. 30,50,00,000 (Rupees Thirty crores fifty lakhs) divided into 3,05,00,000 (Three crores five lakhs) equity shares having face value of Rs. 10 (Rupees Ten) each without any further act or deed by the Resulting Company for purpose of such enhancement of the authorized share capital of the Resulting Company except payment of necessary stamp duties and RoC fees.
- 26.2 Subsequent to enhancement of the authorized share capital of the Resulting Company as contemplated in Clause 26.1 above, the authorized share capital clause of the Memorandum of Association (Clause V) of the Resulting Company shall stand modified and read as follows:-
“The authorised share capital of the Company is Rs. 30,50,00,000 (Rupees Thirty crores fifty lakhs) divided into 3,05,00,000 (Three crores five lakhs) equity shares of Rs. 10 (Rupees Ten) each.”
- 26.3 Pursuant to the effectiveness of Part C of this Scheme, the Resulting Company shall make the requisite filings with the RoC and pay the necessary fees for the increase in its authorised share capital in the manner set out in this Clause 26.
- 26.4 It is hereby clarified that for the purposes of Clauses 26.1 and 26.2 of Part C above, the consent of the shareholders of the Resulting Company to this Scheme shall be deemed to be sufficient for the purposes of effecting amendment in the authorized share capital of the Resulting Company and consequential amendments in Clause V of its Memorandum of Association, and all actions taken in accordance with this Clause 26 of Part C of this Scheme shall be deemed to be in full compliance of Sections 13, 14, 61 and 64 of the 2013 Act and other applicable provisions of the Act and that no further resolutions or actions under Sections 13, 14, 61 and 64 of the 2013 Act and/or any other applicable provisions of the Act, would be required to be separately passed or undertaken by the Resulting Company.

27 ACCOUNTING TREATMENT IN THE BOOKS OF THE DEMERGED COMPANY

Upon Part C the Scheme becoming effective, with effect from the Appointed Date, Demerged Company shall account for the Scheme in its books of accounts in accordance with applicable Indian Accounting Standards and generally accepted accounting principles in India prescribed under Section 133 of the Companies Act, 2013 read with the Companies (Indian Accounting Standards) Rules, 2015, as may be amended from time to time. Accordingly, Demerged Company shall provide the following accounting treatment in its books of accounts:

- (i) The Demerged Company shall reduce from its books of accounts, the carrying amount of all assets and liabilities pertaining to the Demerged Undertaking, being transferred to the Resulting Company;
- (ii) The difference between the book values of assets and the book value of liabilities of the Demerged Undertaking shall be adjusted against general reserves of Demerged Company;
- (iii) For any matter not specifically addressed above, the Board of Directors of Demerged Company is authorized to account for the balances in the manner, as may be deemed fit, in accordance with the prescribed Accounting Standards issued by the Central Government as may be amended from time to time and the Generally Accepted Accounting Principles in India.

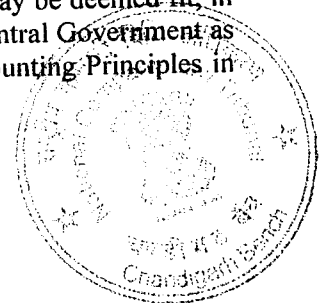
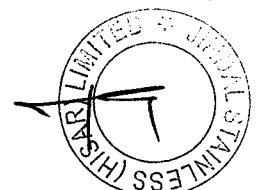
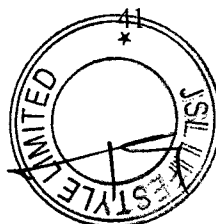
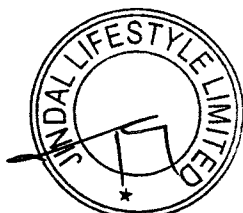
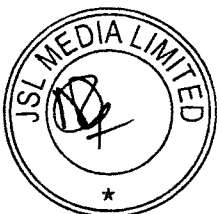

28 ACCOUNTING TREATMENT IN THE BOOKS OF RESULTING COMPANY

Upon Part C of the Scheme becoming effective, the Resulting Company shall account for the Scheme in its books of accounts with effect from the Effective Date in accordance with applicable Indian Accounting Standards and generally accepted accounting principles in India prescribed under Section 133 of the Companies Act, 2013 read with the Companies (Indian Accounting Standards) Rules, 2015, as may be amended from time to time. Accordingly, the Resulting Company shall provide the following accounting treatment in its books of accounts:

- (i) Record the assets and liabilities of the Demerged Undertaking of Demerged Company, vested in it pursuant to Part C this Scheme at their respective carrying values as appearing in the books of the Demerged Company;
- (ii) The aggregate face value of the shares issued by the Resulting Company to the shareholders of the Demerged Company pursuant to Clause 24 of this Scheme shall be credited to its share capital in its books of account;
- (iii) The difference between the face value of the shares issued by the Resulting Company to the shareholders of the Demerged Company as per Clause 24 and the net book value of the assets and liabilities vested from the Demerged Company, shall be recorded as general reserve (debit or credit, as the case may be).

PART D
AMALGAMATION OF AMALGAMATING COMPANY NO. 2 INTO AND WITH THE
AMALGAMATED COMPANY

29 AMALGAMATION OF AMALGAMATING COMPANY NO. 2 INTO AND WITH THE AMALGAMATED COMPANY

29.1 Subject to the provisions of Part D and Part G of this Scheme in relation to the modalities of amalgamation, upon Part D of this Scheme becoming effective on the Effective Date and with effect from the Appointed Date, immediately after giving effect to Part B and Part C of this Scheme, the Amalgamating Company No. 2 along with all its assets, liabilities, rights and obligations and its entire business and undertakings, including all its properties, rights, benefits and interests therein, shall by virtue of this Part D of the Scheme stand amalgamated with, transferred to and vested in the Amalgamated Company, and shall become the assets, liabilities, rights, obligations, business and undertakings of the Amalgamated Company, subject to the existing encumbrances thereon in favour of banks and financial institutions, if any (unless otherwise agreed to by such encumbrance holders), without any further act, instrument or deed being required from the Amalgamating Company No. 2 and/or the Amalgamated Company and without any approval or acknowledgement of any third party, in accordance with Sections 230 to 232 of the Act read with Section 2(1B) of the IT Act and all other applicable provisions of law if any, in accordance with the provisions contained herein.

29.2 Without prejudice to the generality of the above, in particular, the Amalgamating Company No. 2 shall stand amalgamated with the Amalgamated Company in the manner described in the subparagraphs below, subject to the existing encumbrances in favour of banks and financial institutions, if any (unless otherwise agreed to by such encumbrance holders):-

- (i) Upon Part D of this Scheme becoming effective on the Effective Date and with effect from the Appointed Date, immediately after giving effect to Part B and Part C of this Scheme, all the assets (including investments) of the Amalgamating Company No. 2, that are movable in nature or incorporeal or intangible in nature or are otherwise capable of

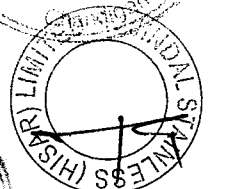
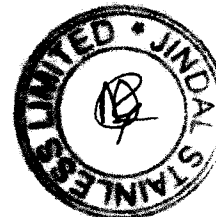
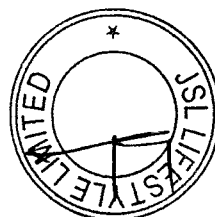
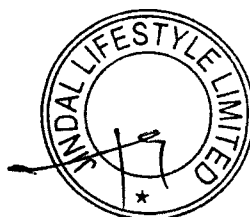
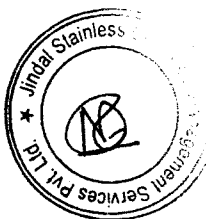

transfer by physical or constructive delivery and/or by endorsement and delivery or by transfer or by delivery instructions in relation to dematerialized shares or by vesting and recordal pursuant to the Scheme, including plant, machinery and equipment, shall stand transferred to and vested in and/or be deemed to be transferred to and vested in the Amalgamated Company and shall become the property and an integral part of the Amalgamated Company, without any further act, instrument or deed required by either of the Amalgamating Company No. 2 or the Amalgamated Company and without any approval or acknowledgement of any third party. The transfer and vesting pursuant to this sub-clause shall be deemed to have occurred by physical or constructive delivery or by endorsement and delivery or by delivery instructions in relation to dematerialized shares or by vesting and recordal, pursuant to this Scheme, as appropriate to the property being transferred and vested and the title to such property shall be deemed to have been transferred and vested accordingly.

- (ii) Upon Part D of this Scheme becoming effective on the Effective Date and with effect from the Appointed Date, immediately after giving effect to Part B and Part C of this Scheme, any and all other movable properties of the Amalgamating Company No. 2 (except those specified elsewhere in this Clause), including cash and cash equivalents, sundry debts and receivables, outstanding loans and advances, if any, recoverable in cash or in kind or for value to be received, actionable claims, bank balances and deposits, if any, with any person or body including without limitation any government, semi-government, local and other authorities and bodies, customers and other persons shall, without any further act, instrument or deed required by either of the Amalgamating Company No. 2 or the Amalgamated Company and without any approval or acknowledgement of any third party, become the property of the Amalgamated Company.
- (iii) Upon Part D of this Scheme becoming effective on the Effective Date and with effect from the Appointed Date, immediately after giving effect to Part B and Part C of this Scheme, all immovable properties of the Amalgamating Company No. 2, including without limitation, all land together with all buildings and structures standing thereon and all rights and interests therein, whether freehold or leasehold or otherwise and all documents of title, rights and easements in relation thereto shall stand transferred and be vested in and/or be deemed to have been transferred vested in the Amalgamated Company and shall become the property and an integral part of the Amalgamated Company, without any further act, instrument or deed being required from the Amalgamating Company No. 2 and/or the Amalgamated Company and without any approval or acknowledgement of any third party. Upon Part D of the Scheme becoming effective on the Effective Date, the Amalgamated Company shall be entitled to exercise all rights and privileges attached to the aforesaid immovable properties and shall be liable to pay all rent, charges and taxes and fulfil all obligations in relation to or applicable to such immovable properties. The Amalgamated Company shall be entitled to seek mutation/substitution of title in its name in such immovable properties, for the purposes of information and record and such mutation / substitution of the title to and interest in such immovable properties shall be made and duly recorded in the name of the Amalgamated Company, by the appropriate authorities pursuant to the sanction of the Scheme by the Court and Part D of the Scheme becoming effective on the Effective Date in accordance with the terms hereof. However, it is hereby clarified that the absence of any such mutation/substitution shall not adversely affect the rights, title or interest of the Amalgamated Company in such immovable properties which shall be deemed to have been transferred to the Amalgamated Company automatically upon the Part D of the Scheme becoming effective on the Effective Date.

- (iv) Upon Part D of this Scheme becoming effective on the Effective Date and with effect from the Appointed Date, immediately after giving effect to Part B and Part C of this Scheme, all debts, liabilities, contingent liabilities, duties and obligations, secured or

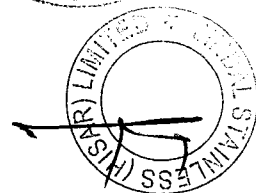
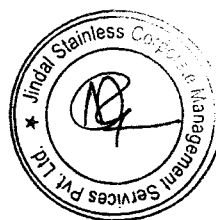
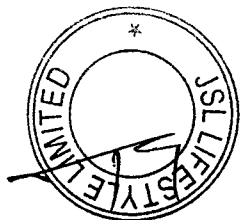
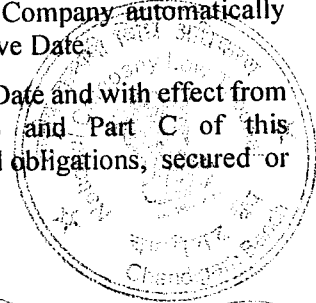
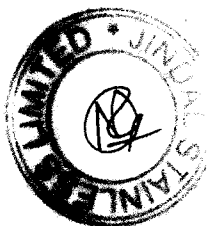

unsecured, whether provided for or not in the books of accounts of the Amalgamating Company No. 2 or disclosed in the balance sheets of the Amalgamating Company No. 2 shall become and be deemed to be the debts, liabilities, contingent liabilities, duties and obligations of the Amalgamated Company without any further act, instrument or deed being required from the Amalgamating Company No. 2 and/or the Amalgamated Company and without any approval or acknowledgement of any third party. The Amalgamated Company undertakes to meet, discharge and satisfy the same in terms of their respective terms and conditions, if any. It is hereby clarified that it shall not be necessary to obtain the consent of any third party or other person, who is a party to any contract or arrangement by virtue of which such debts, liabilities, duties and obligations have arisen in order to give effect to the provisions of this sub-clause. However, the Amalgamated Company shall, if required, file appropriate forms with the RoC accompanied by the sanction order of the Court or a certified copy thereof and execute necessary deeds or documents in relation to creation/satisfaction/modification of charges to the satisfaction of the lenders, pursuant to Part D of this Scheme becoming effective in accordance with the terms hereof. The Amalgamated Company shall be entitled to take the benefit of all duties and charges already paid by the Amalgamating Company No. 2 for the creation/modification of any such security interest. Where any of the loans, liabilities and obligations have been discharged by the Amalgamating Company No. 2 after the Appointed Date but before the Effective Date, such discharge shall be deemed to have been done by the Amalgamating Company No. 2 for and on behalf of the Amalgamated Company.

- (v) Upon Part D of this Scheme becoming effective on the Effective Date and with effect from the Appointed Date, immediately after giving effect to Part B and Part C of this Scheme, all loans, advances, trade receivables and other obligations or liabilities due from, or any guarantees or similar obligations undertaken on behalf of the Amalgamating Company No. 2 to / by the Amalgamated Company or *vice versa*, if any, and all contracts between the Amalgamating Company No. 2 and the Amalgamated Company shall stand automatically cancelled and terminated and shall be of no effect, without any further act, instrument or deed being required from either the Amalgamating Company No. 2 and/or the Amalgamated Company and without any approval or acknowledgement of any third party. No further taxes, fees, duties or charges shall be required to be paid by the Amalgamated Company on account of such cancellation or termination.
- (vi) Upon Part D of the Scheme coming into effect on the Effective Date and with effect from the Appointed Date, immediately after giving effect to Part B and Part C of this Scheme, all incorporeal or intangible property of or in relation to the Amalgamating Company No. 2 shall stand transferred to and vested in the Amalgamated Company, and shall become the property and an integral part of the Amalgamated Company without any further act, instrument or deed required by either the Amalgamating Company No. 2 and/or the Amalgamated Company and without any approval or acknowledgement of any third party.
- (vii) Upon Part D of the Scheme coming into effect on the Effective Date and with effect from the Appointed Date, immediately after giving effect to Part B and Part C of this Scheme, all letters of intent, memoranda of understanding, memoranda of agreements, tenders, bids, letters of award, expressions of interest, experience, and/or performance statements, contracts, deeds, bonds, agreements, guarantees and indemnities, schemes, arrangements, undertakings and other instruments of every nature and description including without limitation, those relating to tenancies, privileges, powers and facilities of every kind and description, to which the Amalgamating Company No. 2 is a party or to the benefit of which the Amalgamating Company No. 2 may be eligible or under which the Amalgamating Company No. 2 is an obligor (except to the extent provided in this Clause) and which are subsisting or having effect immediately prior to Part D of the Scheme coming into effect on the Effective Date, shall be and shall remain in full force

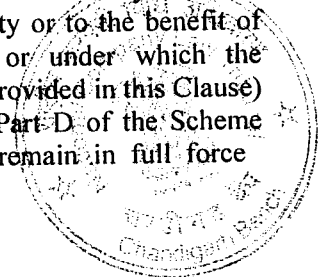
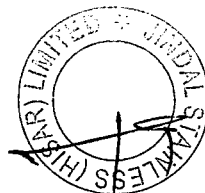
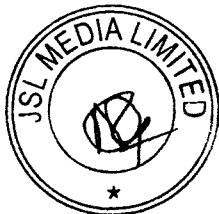

and effect against or in favour of the Amalgamated Company and may be enforced by or against it as fully and effectually as if, instead of the Amalgamating Company No. 2, the Amalgamated Company had been a party or beneficiary or obligee or obligor thereto, without any further act, instrument or deed being required from the Amalgamating Company No. 2 and/or the Amalgamated Company and without any approval or acknowledgement of any third party.

(viii) Upon Part D of the Scheme coming into effect on the Effective Date and with effect from the Appointed Date, immediately after giving effect to Part B and Part C of this Scheme, all statutory or regulatory licenses and permits including without limitation, all such licenses and permits, grants, allotments, recommendations, no-objection certificates, permissions, registrations, approvals, certificates, consents, quotas, exemptions, clearances, tenancies, privileges, powers, offices, facilities, entitlements or rights granted/available/renewed/applied for, to or by the Amalgamating Company No. 2 shall stand transferred to and vested in the Amalgamated Company, without any further act, instrument or deed being required by the Amalgamating Company No. 2 and/or the Amalgamated Company and without any approval or acknowledgement of any third party. Upon Part D of the Scheme coming into effect on the Effective Date, the Amalgamated Company shall be entitled to all the benefits thereof, and shall be liable for all the obligations thereunder. In relation to the same, any procedural requirements required to be fulfilled solely by Amalgamating Company No. 2 (and not by any of their successors), shall be fulfilled by the Amalgamated Company as if it is the duly constituted attorney of the Amalgamating Company No. 2. It is hereby clarified that if the consent or approval (by whatever name called) of any third party or authority is required to give effect to the provisions of this Clause, the said third party or authority shall duly record provide such consent or approval and shall make the necessary substitution/endorsement in the name of the Amalgamated Company pursuant to the sanction of this Scheme by the Court, and upon Part D of this Scheme becoming effective in accordance with the terms hereof. For this purpose, the Amalgamated Company may file appropriate applications/documents with relevant authorities concerned for information and record purposes. However, it is hereby clarified that the absence of any such substitution/endorsement shall not adversely affect the rights, benefits or interest of the Amalgamated Company which shall be deemed to have been transferred to the Amalgamated Company automatically upon the Part D of the Scheme becoming effective on the Effective Date.

(ix) Upon Part D of the Scheme coming into effect on the Effective Date and with effect from the Appointed Date, immediately after giving effect to Part B and Part C of this Scheme, all workmen and employees of the Amalgamating Company No. 2, who are on its payrolls and all other personnel employed by the Amalgamating Company No. 2 shall become employed by the Amalgamated Company with effect from the Effective Date, on such terms and conditions as are no less favourable than those on which they were engaged with the Amalgamating Company No. 2 immediately prior to the Effective Date, without any interruption of service as a result of this amalgamation and transfer. With regard to provident fund, gratuity fund, superannuation fund and any contributions required to be made in relation to employees under any statute or regulation, leave encashment and any other special scheme or benefits created or existing for the benefit of the personnel employed by the Amalgamating Company No. 2 immediately prior to Part D of the Scheme coming into effect on the Effective Date and transferred to the Amalgamated Company, the Amalgamated Company shall stand substituted for the Amalgamating Company No. 2 for all intents and purposes whatsoever, upon Part D of this Scheme becoming effective on the Effective Date, including with regard to the obligation to make contributions to the said funds in accordance with the provisions of such schemes or funds in the respective trust deeds or other documents and/or in accordance with the provisions of Applicable Laws or otherwise. All existing contributions made to such schemes and funds and all benefits accrued thereto shall also

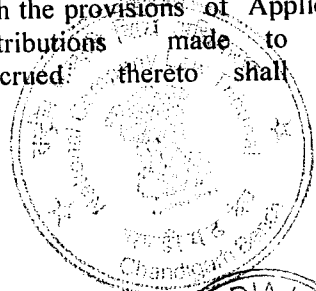
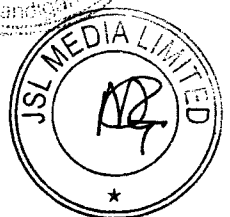
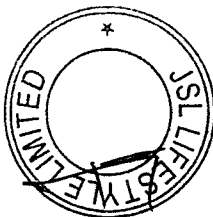
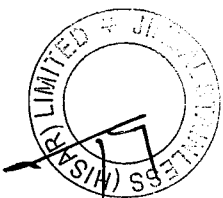
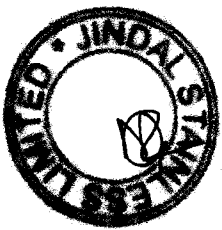

stand transferred in the name of the Amalgamated Company and all such benefits and schemes shall be continued by the Amalgamated Company for the benefit of such personnel employed by the Amalgamating Company No. 2 and transferred to the Amalgamated Company, on the same terms and conditions. Further, it is the aim and intent of the Scheme that all the rights, duties, powers and obligations of the Amalgamating Company No. 2 in relation to such schemes or funds shall become those of the Amalgamated Company. It is clarified that the services of all personnel employed by the Amalgamating Company No. 2 who are entitled to the benefits under such schemes and funds, will be treated as having been continuous and uninterrupted for the purpose of the aforesaid schemes or funds.

- (x) Upon Part D of the Scheme coming into effect on the Effective Date, immediately after giving effect to Part B and Part C of this Scheme, the Amalgamated Company undertakes to continue to abide by any agreement(s)/settlement(s) entered into with any labour unions/employees by the Amalgamating Company No. 2. The Amalgamated Company agrees that for the purpose of payment of any future retrenchment compensation, gratuity and other terminal benefits, the past services of such employees, if any, with the Amalgamating Company No. 2, as the case may be, shall also be taken into account, and agrees and undertakes to pay the same as and when payable. Further, upon Part D of the Scheme coming into effect on the Effective Date, immediately after giving effect to Part B and Part C of this Scheme, any prosecution or disciplinary action initiated, pending or contemplated against and any penalty imposed in this regard on any employee by the Amalgamating Company No. 2 shall be continued or shall continue to operate against the relevant employee and shall be enforced effectively by the Amalgamated Company.
- (xi) Upon Part D of the Scheme coming into effect on the Effective Date and with effect from the Appointed Date, immediately after giving effect to Part B and Part C of this Scheme, all rights, entitlements, licenses, applications and registrations relating to trademarks, service marks, copyrights, domain names, brand name, logos, patents and other intellectual property rights of every kind and description, including without limitations, all rights whether registered, unregistered or pending registration, and the goodwill arising therefrom, if any, to which the Amalgamating Company No. 2 is a party or to the benefit of which the Amalgamating Company No. 2 may be eligible or entitled, shall stand transferred to and vested in the Amalgamated Company, and shall become the rights, entitlement or property of the Amalgamated Company and shall be enforceable by or against the Amalgamated Company, as fully and effectually as if, instead of the Amalgamating Company No. 2, the Amalgamated Company had been a party or beneficiary or obligee thereto or the holder or owner thereof, without any further act, instrument or deed required by either of the Amalgamating Company No. 2 or the Amalgamated Company and without any approval or acknowledgement of any third party.
- (xii) Upon Part D of the Scheme coming into effect on the Effective Date and with effect from the Appointed Date, immediately after giving effect to Part B and Part C of this Scheme, the Amalgamated Company shall be entitled to the benefit of all insurance policies (if any) which have been issued in respect of Amalgamating Company No. 2 and/or any of its assets or employees and the name of the Amalgamated Company shall stand substituted as the "Insured" in all such policies as if the Amalgamated Company was originally a party thereto without any further act, instrument or deed required by either of the Amalgamating Company No. 2 or the Amalgamated Company and without any approval or acknowledgement of any third party. Further, the Amalgamated Company shall be entitled to the benefit of all claims filed, prosecuted, proposed to be filed, pending and/or adjudicated in relation to all insurance policies issued in respect of Amalgamating Company No. 2 and/or any of its assets or employees.
- (xiii) Upon Part D of the Scheme coming into effect on the Effective Date and with effect from the Appointed Date, immediately after giving effect to Part B and Part C of this Scheme,

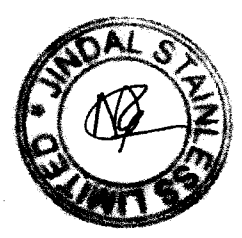
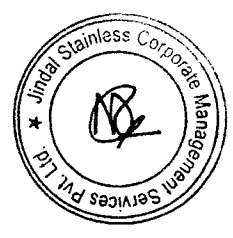
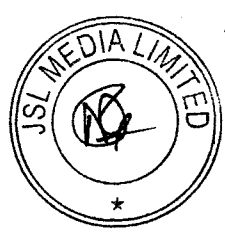
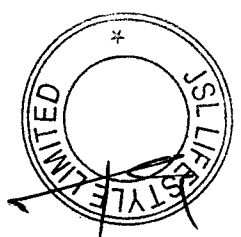
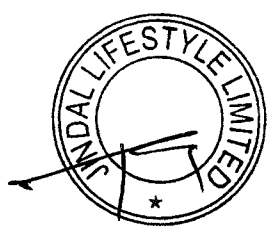
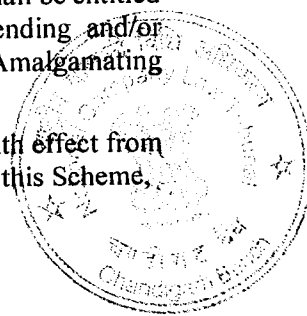
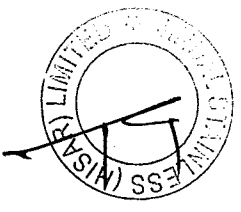

all taxes and duties of whatsoever description ((including but not limited all carry forward tax losses comprising of unabsorbed depreciation, advance tax payments, TDS, TCS, MAT, securities transaction tax, taxes withheld/paid in a foreign country, customs duty, entry tax, value added tax, GST, sales tax, service tax etc.) payable by or refundable to the Amalgamating Company No. 2, including all or any refunds or claims shall be treated as the tax liability or refunds/claims, as the case may be, of the Amalgamated Company, and any tax incentives, advantages, privileges, exemptions, credits, holidays, remissions, reductions etc., as would have been available to the Amalgamating Company No. 2, shall pursuant to this Scheme becoming effective, be available to the Amalgamated Company without any further act, instrument or deed required by either of the Amalgamating Company No. 2 or the Amalgamated Company and without any approval or acknowledgement of any third party but in the manner more particularly set out herein below. Upon Part D of the Scheme coming into effect on the Effective Date and with effect from the Appointed Date, immediately after giving effect to Part B and Part C of this Scheme, all existing and future incentives, un-availed credits and exemptions, benefit of carried forward losses and other statutory benefits, including in respect of income tax (including MAT), excise (including Modvat/ Cenvat), customs, value added tax, sales tax, service tax to which the Amalgamating Company No. 2 is entitled shall be available to and shall stand transferred and vested in the Amalgamated Company without any further act, instrument or deed required by either the Amalgamated Company or the Amalgamating Company No. 2 and without any approval or acknowledgement of any third party. Upon Part D of the Scheme coming into effect on the Effective Date and with effect from the Appointed Date, any tax deducted at source deducted by or on behalf of the Amalgamating Company No. 2 until the Effective Date shall be deemed to have been deducted on behalf of the Amalgamated Company.

- (xiv) Upon Part D of the Scheme coming into effect on the Effective Date and with effect from the Appointed Date, immediately after giving effect to Part B and Part C of this Scheme, the Amalgamated Company shall be entitled to claim the benefit of any and all corporate approvals and limits as may have already been taken by the Amalgamating Company No. 2, including without limitation, the approvals and limits under Sections 62, 179, 180, 185, 186, 188 etc., of the Act, until the time the same are duly modified by the Amalgamated Company.
- (xv) Upon Part D of the Scheme coming into effect on the Effective Date and with effect from the Appointed Date, immediately after giving effect to Part B and Part C of this Scheme, all other estates, assets, rights, title, interests and authorities accrued to and/or acquired by the Amalgamating Company No. 2 shall be deemed to have been accrued to and/or acquired for and on behalf of the Amalgamated Company and shall, upon Part D of this Scheme coming into effect, pursuant to the provisions of the Act, without any further act, instrument or deed be and stand transferred to or vested in and/or be deemed to have been transferred to or vested in the Amalgamated Company to that extent and shall become the estates, assets, right, title, interests and authorities of the Amalgamated Company.
- (xvi) Upon Part D of the Scheme coming into effect on the Effective Date immediately after giving effect to Part B and Part C of this Scheme, all books, record files, papers, computer programs, engineering and process information, manuals, data, production methodologies, production plans, designs, catalogues, quotations, websites, cloud storage, sales and advertising material, marketing strategies, list of present and former customers, customer credit information, customer pricing information, and other records whether in physical form or electronic form or in any other form in connection with or relating to the Amalgamating Company No. 2 shall be deemed to have been transferred to or acquired for and on behalf of the Amalgamated Company and shall, upon Part D of this Scheme coming into effect, without any further act, instrument or deed be and stand transferred to or vested in and/or be deemed to have been transferred to or vested in the

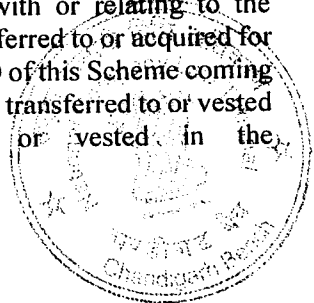
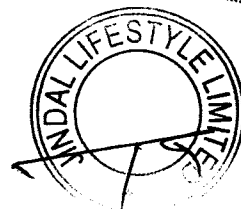
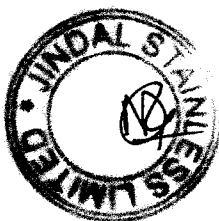
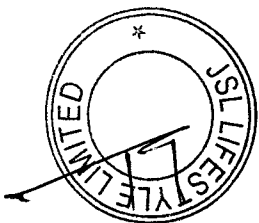

249

Amalgamated Company.

- (xvii) Upon Part D of the Scheme coming into effect on the Effective Date and with effect from the Appointed Date, immediately after giving effect to Part B and Part C of this Scheme, the Amalgamated Company shall bear the burden and the benefits of any legal, tax, quasi-judicial, administrative, regulatory or other proceedings initiated by or against the Amalgamating Company No. 2. If any suit, appeal or other proceeding of whatsoever nature by or against the Amalgamating Company No. 2 shall be pending as on the Effective Date, the same shall not abate, be discontinued or in any way be prejudicially affected by reason of the merger of such Amalgamating Company No. 2 and transfer and vesting of the same in the Amalgamated Company or of anything contained in Part D of this Scheme but the proceedings may be continued, prosecuted and enforced by or against the Amalgamated Company in the same manner and to the same extent as it would or might have been continued, prosecuted and enforced by or against the Amalgamating Company No. 2 as if Part D of this Scheme had not been made effective. Upon Part D of the Scheme becoming effective, the Amalgamated Company undertakes to have such legal or other proceedings initiated by or against the Amalgamating Company No. 2 transferred in its name and to have the same continued, prosecuted and enforced by or against the Amalgamated Company to the exclusion of the Amalgamating Company No. 2. The Amalgamated Company also undertakes to handle all legal or other proceedings which may be initiated against the Amalgamating Company No. 2 after the Effective Date in its own name and account and further undertakes to pay all amounts including interest, penalties, damages etc., pursuant to such legal/ other proceedings.

29.3 Upon Part D of the Scheme coming into effect on the Effective Date with effect from the Appointed Date, the Amalgamated Company shall be entitled to the benefit of the past experience, accreditation, and/or performance of the Amalgamating Company No. 2 for all purposes without any further act, instrument or deed required by either of the Amalgamating Company No. 2 or the Amalgamated Company and without any approval or acknowledgement being required from any third party. If any instrument or deed or document is required or deemed necessary or expedient to give effect to the provisions of this Clause by the Amalgamated Company, the Amalgamated Company shall, under the provisions of Part D of the Scheme, be deemed to be duly authorized to execute all such writings on behalf of the Amalgamating Company No. 2 and to carry out or perform all such formalities or compliances referred to above on behalf of the Amalgamating Company No. 2.

30 CONDUCT OF AFFAIRS UNTIL THE EFFECTIVE DATE

30.1 In the event Part of D of this Scheme becomes and with effect from the Appointed Date and up to and including the Effective Date:

- (i) the Amalgamating Company No. 2 shall be deemed to have carried on the business activities of the Amalgamating Company No. 2 and stand possessed of the properties and assets of the Amalgamating Company No. 2, for, on behalf of and in trust for, the Amalgamated Company; and
- (ii) all profits or income accruing to or received by the Amalgamating Company No. 2 and all taxes paid thereon (including but not limited to advance tax, tax deducted at source, tax collected at source, minimum alternate tax, fringe benefit tax, securities transaction tax, taxes withheld/paid in a foreign country, customs duty, entry tax, value added tax, goods and services tax, sales tax, service tax etc.) or losses arising in or incurred by the Amalgamating Company No. 2 shall, for all purposes, be treated as and deemed to be the profits, income, taxes or losses, as the case may be, of the Amalgamated Company.

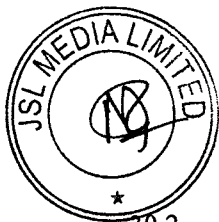

30.2

The Amalgamated Company shall also be entitled, pending the sanction of this Scheme, to apply to the central government, state government, and all other agencies, departments, statutory authorities and Governmental Authorities concerned, wherever necessary, for such consents,

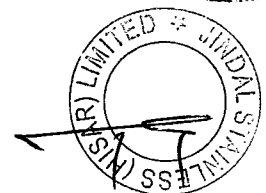
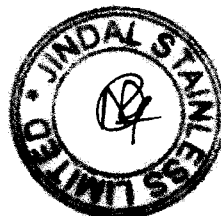
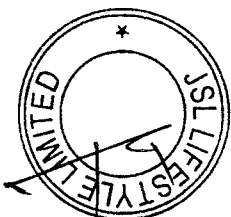
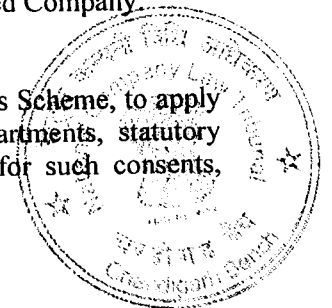

approvals and sanctions which the Amalgamated Company may require including the registration, approvals, exemptions, reliefs, etc., as may be required/granted under any Applicable Law for the time being in force for carrying on the business of the Amalgamating Company No. 2.

31 TREATMENT OF TAXES

- 31.1 Upon Part D of this Scheme becoming effective and with effect from the Appointed Date immediately after Part B and Part C of the Scheme being effective, any surplus in the provision for taxation/ duties/ levies account including but not limited to the advance tax, TDS or TCS and MAT credit, CENVAT credit, or GST Credit, as on the date immediately preceding the Appointed Date will also be transferred from the Amalgamating Company No. 2 to the Amalgamated Company. Any refund under the IT Act or other Applicable Laws dealing with taxes/ duties/ levies, including GST, allocable or related to the business of Amalgamating Company No. 2 or due to the Amalgamating Company No. 2, consequent to the assessment made in respect of the Amalgamating Company No. 2, for which no credit is taken in the book of accounts of the Amalgamating Company No. 2 as on the date immediately preceding the Appointed Date, shall also belong to and be received by the Amalgamated Company and shall be deemed to have been on account of or paid by the Amalgamated Company and the relevant Governmental Authorities shall be bound to transfer to the account of and give credit for the same to the Amalgamated Company upon the approval of this Scheme by the Court upon relevant proof and documents being provided to the said Governmental Authorities.
- 31.2 Without prejudice to the generality of the above, deductions, benefits, right to carry forward and set off accumulated losses and unabsorbed depreciation, and credits (including but not limited to MAT/CENVAT credits etc.) under the IT Act, Goods and Services Tax, Service Tax or, any central government/state government incentive schemes etc., to which the Amalgamating Company No. 2 is / would be entitled to in terms of the Applicable Laws of the central and state government or of any foreign jurisdictions, shall be available to and vest in the Amalgamated Company.
- 31.3 Upon Part D of this Scheme becoming effective and with effect from the Appointed Date immediately after Part B and Part C of the Scheme being effective, the tax payments (including without limitation income tax, GST, tax on distribution of dividends, excise duty, central sales tax, custom duty, applicable state value added tax and entry tax or any other taxes as may be applicable from time to time) whether by way of tax deducted at source or collected at source by the parties, advance tax or otherwise howsoever, by the Amalgamating Company No. 2 on or after the Appointed Date, shall be deemed to be paid by the Amalgamated Company and the Amalgamated Company shall be entitled to claim credit for such taxes/duties paid against its tax/ duty liabilities, notwithstanding that the certificates/ challans or other documents for payment of such taxes/duties are in the name of Amalgamating Company No. 2, as the case may be.
- 31.4 Upon Part D of the Scheme becoming effective on the Effective Date, with effect from the Appointed Date, immediately after Part B and Part C of the Scheme being effective, the Amalgamating Company No. 2 and the Amalgamated Company are expressly permitted to prepare and/or revise, as the case may be, their financial statements and statutory / tax returns along with the prescribed forms, filings and annexures under the IT Act and/or in relation to central sales tax, custom duty, entry tax, applicable state value added tax, GST and other tax laws, if required, to give effect to the provisions of the Scheme.
- 31.5 Upon Part D of the Scheme coming into effect on the Effective Date and with effect from the Appointed Date immediately after Part B and Part C of the Scheme, all inter-party transactions between Amalgamating Company No. 2 and the Amalgamated Company shall be considered as intra-party transactions for all purposes (including for tax compliances, credits, refunds, etc.).
- 31.6 Upon Part D of the Scheme coming into effect on the Effective Date and with effect from the Appointed Date immediately after Part B and Part C of the Scheme, obligation for deduction of

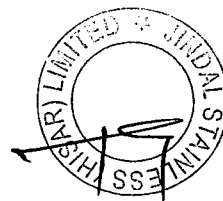
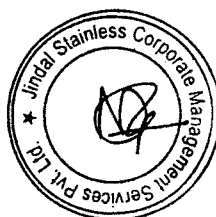
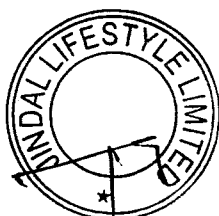
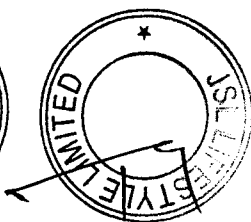
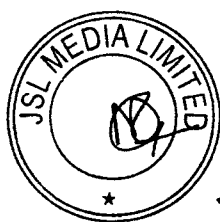

tax at source on any payment made by or to be made by the Amalgamating Company No. 2 or for collection of tax at source on any supplies made by or to be made by Amalgamating Company No. 2 shall be made or deemed to have been made and duly complied with by the Amalgamated Company. Further, any tax deducted at source or collected at source by the Amalgamating Company No. 2 and Amalgamated Company on transactions with each other, if any (from the Appointed Date until Effective Date) and deposited with Governmental Authorities shall be deemed to be advance tax paid by the Amalgamated Company and shall, in all proceedings be dealt with accordingly.

- 31.7 Upon Part D of the Scheme coming into effect on the Effective Date and with effect from the Appointed Date immediately after Part B and Part C of the Scheme, all tax compliances under any tax laws by the Amalgamating Company No. 2 on or after the Appointed Date shall be deemed to be made by the Amalgamated Company.
- 31.8 Upon Part D of the Scheme coming into effect on the Effective Date and with effect from the Appointed Date immediately after Part B and Part C of the Scheme, all tax assessment proceedings and appeals of whatsoever nature by or against the Amalgamating Company No. 2, pending or arising as at the Effective Date, shall be continued and/enforced by or against the Amalgamated Company in the same manner and to the same extent as would or might have been continued and enforced by or against the Amalgamating Company No. 2. Further, the aforementioned proceedings shall neither abate or be discontinued nor be in any way prejudicially affected by the reason of the amalgamation of the Amalgamating Company No. 2 with the Amalgamated Company or anything contained in Part D of this scheme.
- 31.9 Upon Part D of the Scheme coming into effect on the Effective Date and with effect from the Appointed Date immediately after Part B and Part C of the Scheme, all the expenses incurred by the Amalgamating Company No. 2 and the Amalgamated Company in relation to the amalgamation of the Amalgamating Company No. 2 with the Amalgamated Company as per Part D of this Scheme, including stamp duty expenses and / or transfer charges, if any, shall be allowed as deduction to the Amalgamated Company in accordance with Section 35DD of the IT Act over a period of 5 (five) years beginning with the previous year in which Part D of the Scheme becomes effective.
- 31.10 With effect from the Appointed Date, all the deductions otherwise admissible to the Amalgamating Company No. 2, including payment admissible on actual payment or on deduction of appropriate taxes or on payment of TDS (like Section 43B, Section 40, Section 40A etc. of the IT Act) will be eligible for deduction to Amalgamated Company upon fulfilment of required conditions under the IT Act.
- 31.11 The amalgamation under this Scheme is in compliance with the IT Act, specifically Section 2(1B) and other relevant provisions. If any of the terms of this Scheme are inconsistent with the provisions of Sections 2(1B) of the IT Act, the provisions of Sections 2(1B) of the IT Act shall to the extent of such inconsistency, prevail and this the Scheme shall, stand and be deemed to be modified to that extent to comply with the said provisions and such modifications shall not affect the other parts of this the Scheme.

32 CONDUCT OF AFFAIRS AFTER THE EFFECTIVE DATE

32.1 The Amalgamated Company, shall, at any time after Part D of this Scheme becomes effective on the Effective Date immediately after giving effect to Part B and Part C of this Scheme, in accordance with the provisions hereof, if so required under any law, contract or otherwise, be entitled to do and take all such actions as may be required to give full effect to the provisions of this Part D and for this purpose the Amalgamated Company shall, under the provisions hereof, be deemed to be authorised on behalf of the Amalgamating Company No. 2. Without prejudice to the generality of the above, the Amalgamated Company shall be entitled and deemed to be authorised to:-

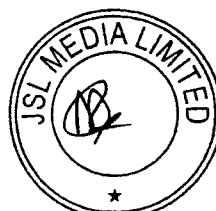
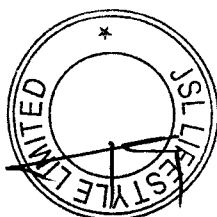
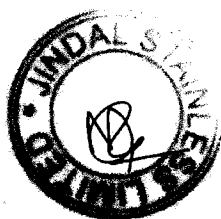
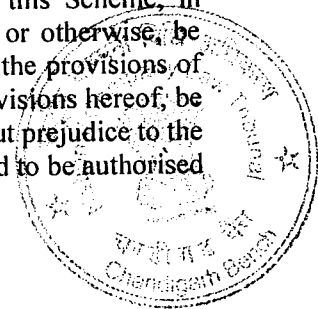
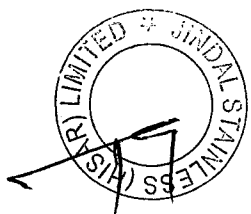

- (i) execute appropriate deeds of confirmation or other writings or arrangements with any party to any contract or arrangement (including without limitation any bank guarantee, performance guarantee, fixed deposit, letters of credit, bill of entry etc.) in relation to which the Amalgamating Company No. 2 have been a party or to the benefit of which the Amalgamating Company No. 2 may have been entitled, and to make any filings with the regulatory authorities, in order to give formal effect to the provisions of Part D of the Scheme; and
- (ii) do all such acts or things as may be necessary to effectually transfer/obtain in favour of the Amalgamated Company the approvals, consents, bids, awards, tenders, exemptions, registrations, no-objection certificates, permits, quotas, rights, entitlements, licenses and certificates etc. which were held or enjoyed by the Amalgamating Company No. 2 including without limitation, execute all necessary or desirable writings and confirmations on behalf of the Amalgamating Company No. 2 and to carry out and perform all such acts, formalities and compliances as may be required in this regard;

32.2 The provisions of this Clause shall operate notwithstanding anything to the contrary contained in any deed or writing or certificate or license or the terms of sanction or issue or any security, all of which instruments and documents shall stand modified and/or superseded by the foregoing provisions.

33 SAVING OF CONCLUDED TRANSACTIONS

Except as expressly provided hereunder including in Clause 31.4 and Clause 31.5, the transfer of properties and liabilities to, and the continuance of proceedings by or against, the Amalgamated Company as envisaged in this Part D shall not affect any transaction or proceedings already concluded by Amalgamating Company No. 2 on or before the Appointed Date and after the Appointed Date and until the Effective Date, and to such end and intent the Amalgamated Company accepts and adopts all acts, deeds and things done and executed by the Amalgamating Company No. 2 in respect thereto as done and executed on behalf of itself.

34 DISCHARGE OF CONSIDERATION

34.1 Upon Part D of the Scheme coming into effect on the Effective Date, immediately after Part B and Part C of the Scheme being effective, and upon the amalgamation of the Amalgamating Company No. 2 into and with the Amalgamated Company, the Board of Directors (including any committee thereof) of the Amalgamated Company shall determine a record date, being a date on the filing of the order of the Court sanctioning the Scheme with the RoC ("**Part D Record Date**"), for the allotment of the equity shares of the Amalgamated Company having face value of Rs. 2 each to the shareholders of the Amalgamating Company No. 2 as on the Part D Record Date, in consideration for the amalgamation of the Amalgamating Company No. 2 with and into the Amalgamated Company.

34.2 Based on (i) the valuation report issued by Niranjn Kumar, a registered valuer, dated December 29, 2020, appointed by both the Amalgamating Company No. 2 and the Amalgamated Company; and (ii) the fairness opinion issued by SBI Capital Markets Limited, an independent SEBI registered merchant banker on such valuation, dated December 29, 2020, appointed by both the Amalgamating Company No. 2 and the Amalgamated Company, the Board of Directors have determined the following share exchange ratio in accordance with the SEBI Circular:

"101 (One hundred one) fully paid-up equity shares of face value of Rs. 2 (Rupees Two) each of the Amalgamated Company shall be issued and allotted as fully paid-up equity shares to the equity shareholders of Amalgamating Company No. 2, for every 100 (One hundred) fully paid-up equity shares of face value of Rs. 10 each held by them in Amalgamating Company No. 2."

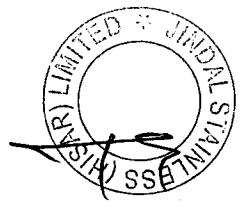
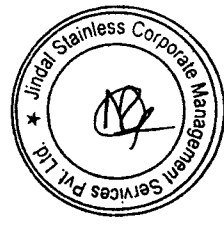
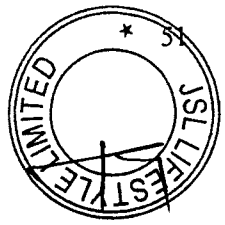
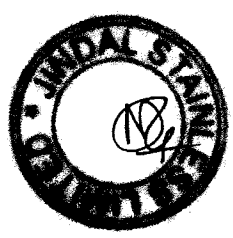
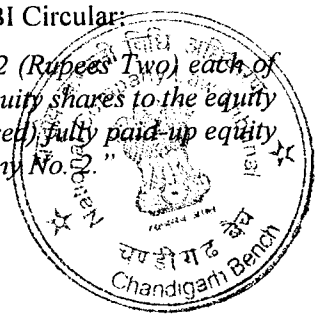
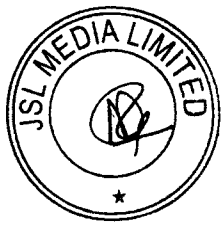

253

- 34.3 To the extent Amalgamated Company or its subsidiaries are shareholders of the Amalgamating Company No. 2 as on the Part D Record Date, no shares shall be issued by the Amalgamated Company in lieu of any such shareholding in Amalgamating Company No. 2.
- 34.4 Any fractional entitlement of shares arising out of the aforesaid share exchange process, if any, will be rounded off to the nearest higher integer.
- 34.5 In the event of any increase in the issued, subscribed or paid up share capital of the Amalgamating Company No. 2 or the Amalgamated Company or issuance of any instruments convertible into equity shares or restructuring of its equity share capital including by way of share split / consolidation / issue of bonus shares, free distribution of shares or instruments convertible into equity shares or other similar action in relation to share capital of the Amalgamating Company No. 2 or the Amalgamated Company at any time before the Part D Record Date, except on account of exercise of the Warrants already issued by the Amalgamated Company, the share exchange ratio shall be adjusted appropriately to take into account the effect of such issuance or corporate actions and assuming conversion of any such issued instruments convertible into equity shares.
- 34.6 The new equity shares of the Amalgamated Company issued as per this Clause shall be subject to the Memorandum and Articles of Association of Amalgamated Company and shall rank *pari passu* in all respects, including dividend and voting rights, with the existing equity shares of the Amalgamated Company.
- 34.7 The issue and allotment of new equity shares by Amalgamated Company to the shareholders of the Amalgamating Company No. 2 as provided in this Part D of the Scheme is an integral part thereof and shall be deemed to have been carried out in full compliance with all the procedures laid down under Section 62 read with Section 42 of the Act and any other applicable provisions of the Act and the rules and regulations issued thereunder.
- 34.8 In accordance with the regulatory requirements, all new equity shares required to be issued by the Amalgamated Company to the shareholders of the Amalgamating Company No. 2 shall be issued in dematerialized form and shall be credited to the depository account of the equity shareholders of the Amalgamating Company No. 2 to the extent the details of such depository participant accounts have been provided to/are available with the Amalgamating Company No. 2 before the Part D Record Date.
- 34.9 In terms of the provisions of the SEBI (Listing Obligations and Disclosure Requirements) Regulations, 2015, relevant listing agreement, SEBI Circular and other Applicable Laws, if any, in each case, as amended, new equity shares to be issued by the Amalgamated Company to the shareholders of the Amalgamating Company No. 2, pursuant to this Scheme, shall be listed on all the Stock Exchanges on which the equity shares of the Amalgamated Company are listed as on the Effective Date. The Amalgamated Company will make necessary application(s) to the designated stock exchange and other competent authorities, if any, for this purpose and will comply with the provisions of all Applicable Laws in this regard.
- 34.10 Shares allotted pursuant to this Scheme may remain frozen in the Depositories system till listing/trading permission is given by the Stock Exchanges.
- 34.11 The Board of Directors (including any committee thereof) of Amalgamating Company No. 2 and the Amalgamated Company shall be empowered to remove such difficulties as may arise in the course of implementation of this Scheme and registration of new shareholders in the Amalgamated Company on account of the difficulties if any in the transition period.

35 CHANGE IN AUTHORISED SHARE CAPITAL OF THE AMALGAMATED COMPANY

- 35.1 Upon this Scheme becoming effective on the Effective Date immediately after Part B and Part C of the Scheme being effective, as an integral part of this Scheme, the authorised share capital of the Amalgamating Company No. 2 as on the Effective Date shall stand transferred to and be

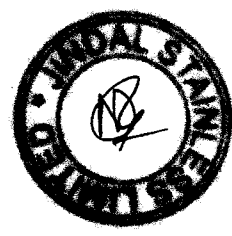
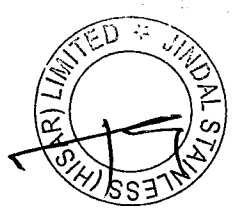
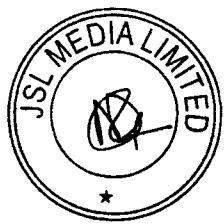
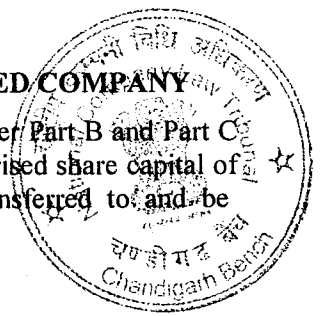

52

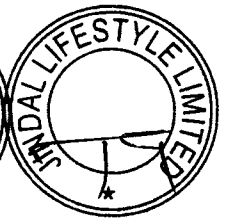
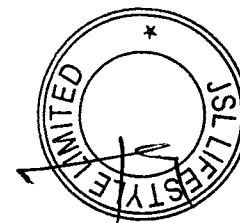

merged/amalgamated with the authorised share capital of the Amalgamated Company, and the fee, if any, paid by the Amalgamating Company No. 2 on its authorised share capital shall be set off against any fee payable by the Amalgamated Company on such increase in its authorised share capital, consequent to this Part D of the Scheme. Accordingly, Clause V of the Memorandum of Association of the Amalgamated Company shall stand modified and shall read as under:-

“The Authorised Share Capital of the Company is Rs. 243,00,00,000 (Rupees Two Hundred Forty Three Crore) consisting of 103,50,00,000 (One hundred three crore fifty Lakhs) Equity Shares having face value of Rs. 2 (Rupees Two) and 18,00,00,000 (Eighteen Crore) preference share having face value of Rs. 2 (Rupees Two).”

35.2 It is hereby clarified that the consent of the shareholders of the Amalgamated Company and shareholders of the Amalgamating Companies to Part D of this Scheme shall be sufficient for the purposes of effecting the aforesaid amendments in the Memorandum of Association of the Amalgamated Company and that no further resolutions, whether under the applicable provisions of the Act or under the Articles of Association, shall be required to be separately passed. All actions taken in accordance with this Clause 35 of Part D of this Scheme shall be deemed to be in full compliance of Sections 61 and 64 and other applicable provisions of the Act and rules and regulations issued thereunder and no further resolutions or actions under any other provisions of the Act or the rules or regulations issued thereunder would be required to be separately passed or undertaken by the Amalgamated Company.

36 DISSOLUTION OF AMALGAMATING COMPANY NO. 2

36.1 Upon Part D of this Scheme becoming effective on the Effective Date immediately after Part B and Part C of the Scheme being effective, Amalgamating Company No. 2 shall stand automatically dissolved as an integral part of this Scheme, without being liquidated or wound-up and without requiring any further act, instrument or deed from the Amalgamating Company No. 2 and/or the Amalgamated Company.

36.2 It is hereby clarified that upon the dissolution of the Amalgamating Company No. 2, in the event there are any further acts, deeds or instruments to be executed to make Part C of the Scheme effective, then the Amalgamated Company shall be able to execute such acts, deeds or instruments without any further act, deed or instrument required from either the Amalgamated Company and/or the Amalgamating Company No. 2.

37 ACCOUNTING TREATMENT

Upon Part D of the Scheme becoming effective, with effect from the Appointed Date, the Amalgamated Company shall account for the amalgamation in its books of accounts, as per ‘Acquisition Method’ in accordance with accounting principles as laid down in Ind AS-103 notified under Section 133 of the Act and under the Companies (Indian Accounting Standards) Rules, 2015, as may be amended from time to time, such that:

- (i) In line with the recognition principles provided under Indian Accounting Standard 103 on Business Combinations, the Amalgamated Company shall recognise all assets and liabilities of the Amalgamating Company No. 2 transferred to and vested in the Amalgamated Company pursuant to this Scheme at their respective fair values as on the Appointed Date. Such assets may also include acquired identifiable intangible assets, whether previously recorded in the books of accounts of the Amalgamating Company No. 2 or not. Upon the Part D of the Scheme coming into effect, the above recognition shall result in the Amalgamated Company recording all the assets and liabilities of the Amalgamating Company No. 2 transferred to and vested in it

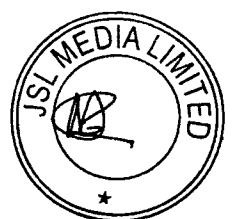
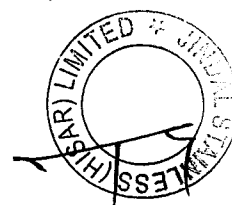
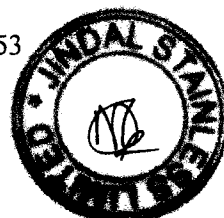
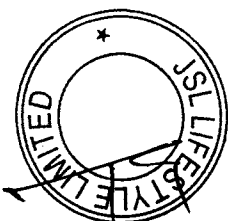

255

pursuant to Part D of this Scheme.

- (ii) The Amalgamated Company shall record issuance of the new equity shares at fair value and accordingly credit to its share capital account the aggregate face value of the new equity shares issued by the Amalgamated Company. The excess of the fair value of the new equity shares over the face value of new equity shares issued by the Amalgamated Company in accordance with Clause 34 shall be credited to the securities premium account.
- (iii) Investment held by Amalgamating Company no. 1 in the Amalgamating Company No. 2 shall be cancelled.
- (iv) Inter-company balances between the Amalgamated Company and the Amalgamating Company No. 2, if any, shall stand cancelled and there shall be no further obligation in that behalf.
- (v) Excess, if any, of fair value of new equity shares issued and cancellation of investments as per sub-Clause (ii) and (iii) respectively above the fair value of net assets taken over as per sub-Clause (i) above, after giving the effect to sub-Clause (iv) above, shall be recorded as goodwill. In case of deficit, it shall be credited to capital reserve account.

PART E
AMALGAMATION OF AMALGAMATING COMPANY NO. 3 INTO AND WITH THE
AMALGAMATED COMPANY

38 AMALGAMATION OF AMALGAMATING COMPANY NO. 3 INTO AND WITH THE AMALGAMATED COMPANY

38.1 Subject to the provisions of Part E and Part G of this Scheme in relation to the modalities of amalgamation, upon Part E of this Scheme becoming effective on the Effective Date and with effect from the Appointed Date, immediately after giving effect to Part B of the Scheme, the Amalgamating Company No. 3 along with all its assets, liabilities, rights and obligations and its entire business and undertakings, including all its properties, rights, benefits and interests therein, shall by virtue of this Part E of the Scheme stand amalgamated with, transferred to and vested in the Amalgamated Company, and in each case shall become the assets, liabilities, rights, obligations, business and undertakings of the Amalgamated Company, subject to the existing encumbrances thereon in favour of banks and financial institutions, if any (unless otherwise agreed to by such encumbrance holders), without any further act, instrument or deed being required from the Amalgamating Company No. 3 and/or the Amalgamated Company and without any approval or acknowledgement of any third party, in accordance with Sections 230 to 232 of the Act read with Section 2(1B) of the IT Act and all other applicable provisions of law if any, in accordance with the provisions contained herein.

38.2 Without prejudice to the generality of the above, in particular, the Amalgamating Company No. 3 shall stand amalgamated with the Amalgamated Company in the manner described in the subparagraphs below, subject to the existing encumbrances in favour of banks and financial institutions, if any (unless otherwise agreed to by such encumbrance holders):-

- (i) Upon Part E of this Scheme becoming effective on the Effective Date and with effect from the Appointed Date, immediately after giving effect to Part B of the Scheme, all the assets (including investments) of the Amalgamating Company No. 3, that are movable in nature or incorporeal or intangible in nature or are otherwise capable of transfer by physical or constructive delivery and/or by endorsement and delivery or by transfer or by delivery instructions in relation to dematerialized shares or by vesting and recordal pursuant to the Scheme, including plant, machinery and equipment, shall stand transferred to and vested in

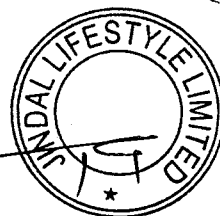
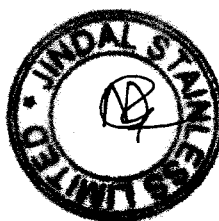
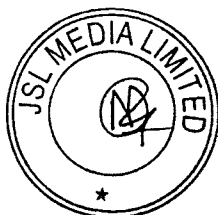
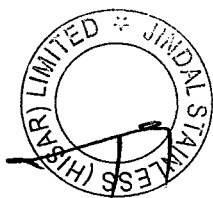
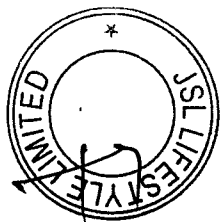
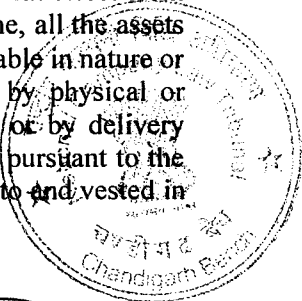

256

and/or be deemed to be transferred to and vested in the Amalgamated Company and shall become the property and an integral part of the Amalgamated Company, without any further act, instrument or deed required from the Amalgamating Company No. 3 and/or the Amalgamated Company and without any approval or acknowledgement of any third party. The transfer and vesting pursuant to this sub-clause shall be deemed to have occurred by physical or constructive delivery or by endorsement and delivery or by delivery instructions in relation to dematerialized shares or by vesting and recordal, pursuant to this Scheme, as appropriate to the property being transferred and vested and the title to such property shall be deemed to have been transferred and vested accordingly.

(ii) Upon Part E of this Scheme becoming effective on the Effective Date and with effect from the Appointed Date, immediately after giving effect to Part B of the Scheme, all other movable properties of the Amalgamating Company No. 3 (except those specified elsewhere in this Clause), including cash and cash equivalents, sundry debts and receivables, outstanding loans and advances, if any, recoverable in cash or in kind or for value to be received, actionable claims, bank balances and deposits, if any, with any person or body including without limitation any government, semi-government, local and other authorities and bodies, customers and other persons shall, without any further act, instrument or deed required from the Amalgamating Company No. 3, and/or the Amalgamated Company and without any approval or acknowledgement of any third party, become the property of the Amalgamated Company.

(iii) Upon Part E of this Scheme becoming effective on the Effective Date and with effect from the Appointed Date, immediately after giving effect to Part B of the Scheme, all immovable properties of the Amalgamating Company No. 3, including without limitations, all land together with all buildings and structures standing thereon and all rights and interests therein, whether freehold or leasehold or otherwise and all documents of title, rights and easements in relation thereto shall stand transferred and be vested in and/or be deemed to have been transferred vested in the Amalgamated Company and shall become the property and an integral part of the Amalgamated Company, without any further act, instrument or deed being required from the Amalgamating Company No. 3 and/or the Amalgamated Company and without any approval or acknowledgement of any third party. Upon Part E of the Scheme becoming effective on the Effective Date, immediately after giving effect to Part B of the Scheme, the Amalgamated Company shall be entitled to exercise all rights and privileges attached to the aforesaid immovable properties and shall be liable to pay all rent, charges and taxes and fulfil all obligations in relation to or applicable to such immovable properties of Amalgamating Company No. 3. The Amalgamated Company shall be entitled to seek mutation/substitution of title in its name in such immovable properties, for the purposes of information and record and such mutation / substitution of the title to and interest in such immovable properties shall be made and duly recorded in the name of the Amalgamated Company, by the appropriate authorities pursuant to the sanction of the Scheme by the Court and Part E of the Scheme becoming effective on the Effective Date, immediately after giving effect to Part B of the Scheme, in accordance with the terms hereof. However, it is hereby clarified that the absence of any such mutation/substitution shall not adversely affect the rights, title or interest of the Amalgamated Company in such immovable properties which shall be deemed to have been transferred to the Amalgamated Company automatically upon the Part E of the Scheme becoming effective on the Effective Date.

(iv) Upon Part E of this Scheme becoming effective on the Effective Date and with effect from the Appointed Date, immediately after giving effect to Part B of the Scheme, all debts, liabilities, contingent liabilities, duties and obligations, secured or unsecured, whether provided for or not in the books of accounts of the Amalgamating Company No. 3, disclosed in the balance sheets of the Amalgamating Company No. 3, shall become and be deemed to be the debts, liabilities, contingent liabilities, duties and obligations of the Amalgamated Company without any further act, instrument or deed being required by

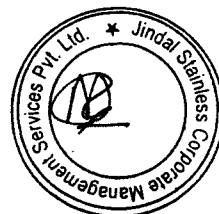
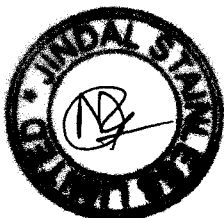
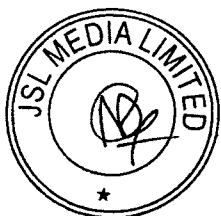
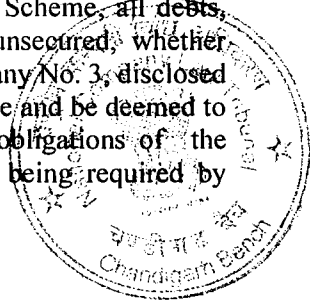
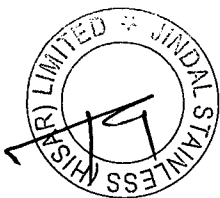
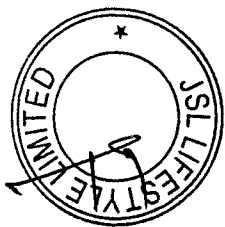

257

either the Amalgamating Company No. 3 or the Amalgamated Company and without any approval or acknowledgement of any third party. The Amalgamated Company undertakes to meet, discharge and satisfy the same in terms of their respective terms and conditions, if any. It is hereby clarified that it shall not be necessary to obtain the consent of any third party or other person, who is a party to any contract or arrangement by virtue of which such debts, liabilities, duties and obligations have arisen in order to give effect to the provisions of this sub-clause. However, the Amalgamated Company shall, if required, file appropriate forms with the RoC accompanied by the sanction order of the Court or a certified copy thereof and execute necessary deeds or documents in relation to creation/satisfaction/modification of charges to the satisfaction of the lenders, pursuant to Part E of this Scheme becoming effective, immediately after giving effect to Part B of the Scheme, in accordance with the terms hereof. The Amalgamated Company shall be entitled to take the benefit of all duties and charges already paid by the Amalgamating Company No. 3 for the creation/modification of any such security interest. Where any of the loans, liabilities and obligations have been discharged by the Amalgamating Company No. 3, after the Appointed Date but before the Effective Date, such discharge shall be deemed to have been done by the Amalgamating Company No. 3, for and on behalf of the Amalgamated Company.

- (v) Upon Part E of this Scheme becoming effective on the Effective Date and with effect from the Appointed Date, immediately after giving effect to Part B of the Scheme, all loans, advances, trade receivables and other obligations or liabilities due from, or any guarantees or similar obligations undertaken on behalf of the Amalgamating Company No. 3 to / by the Amalgamated Company or *vice versa*, if any, and all contracts between the Amalgamating Company No. 3, with the Amalgamated Company shall stand automatically cancelled and terminated and shall be of no effect, without any further act, instrument or deed being required from the Amalgamating Company No. 3 and/or the Amalgamated Company and without any approval or acknowledgement of any third party. No further taxes, fees, duties or charges shall be required to be paid by the Amalgamated Company on account of such cancellation or termination.
- (vi) Upon Part E of the Scheme coming into effect on the Effective Date and with effect from the Appointed Date, immediately after giving effect to Part B of the Scheme, all incorporeal or intangible property of or in relation to the Amalgamating Company No. 3 shall stand transferred to and vested in the Amalgamated Company, and shall become the property and an integral part of the Amalgamated Company without any further act, instrument or deed required from the Amalgamating Company No. 3 and/or the Amalgamated Company and without any approval or acknowledgement of any third party.
- (vii) Upon Part E of the Scheme coming into effect on the Effective Date and with effect from the Appointed Date, immediately after giving effect to Part B of the Scheme, all letters of intent, memoranda of understanding, memoranda of agreements, tenders, bids, letters of award, expressions of interest, experience and/or performance statements, contracts, deeds, bonds, agreements, guarantees and indemnities, schemes, arrangements, undertakings and respective other instruments of every nature and description including without limitation, those relating to the respective tenancies, privileges, powers and facilities of every kind and description, to which the Amalgamating Company No. 3 is a party or to the benefit of which the Amalgamating Company No. 3 may be eligible or under which the Amalgamating Company No. 3 is an obligor (except to the extent provided in this Clause) and which are subsisting or having effect immediately prior to Part E of the Scheme coming into effect on the Effective Date, shall be and shall remain in full force and effect against or in favour of the Amalgamated Company and may be enforced by or against it as fully and effectually as if, instead of the Amalgamating Company No. 3, the Amalgamated Company had been a party or beneficiary or obligee or obligor thereto, without any further act, instrument or deed being required from the Amalgamating Company No. 3 and/or the Amalgamated Company and without any approval or acknowledgement of any third party.

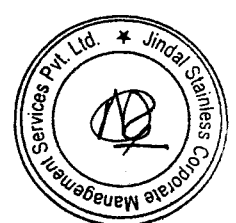
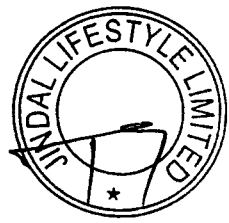
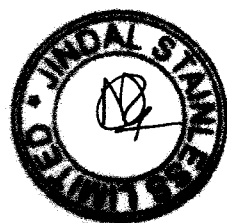
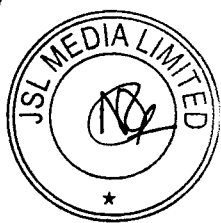
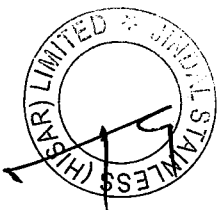
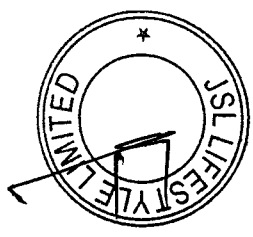

258

- (viii) Upon Part E of the Scheme coming into effect on the Effective Date and with effect from the Appointed Date, immediately after giving effect to Part B of the Scheme, all statutory or regulatory licenses and permits including without limitation, all such licenses and permits, grants, allotments, recommendations, no-objection certificates, permissions, registrations, approvals, certificates, consents, quotas, exemptions, clearances, tenancies, privileges, powers, offices, facilities, entitlements or rights granted/available/renewed/applied for, to or by the Amalgamating Company No. 3 shall stand transferred to and vested in the Amalgamated Company, without any further act, instrument or deed being required on the part of the Amalgamating Company No. 3, and/or on the part of the Amalgamated Company and without any approval or acknowledgement of any third party. Upon Part E of the Scheme coming into effect on the Effective Date, immediately after giving effect to Part B of the Scheme, the Amalgamated Company shall be entitled to all respective the benefits thereof, and shall be liable for all the obligations thereunder. In relation to the same, any procedural requirements required to be fulfilled solely by the Amalgamating Company No. 3 (and not by any of their successors), shall be fulfilled by the Amalgamated Company as if it is the duly constituted attorney of the Amalgamating Company No. 3. It is hereby clarified that if the consent or approval (by whatever name called) of any third party or authority is required to give effect to the provisions of this Clause, the said third party or authority shall duly record provide such consent or approval and shall make the necessary substitution/endorsement in the name of the Amalgamated Company pursuant to the sanction of this Scheme by the Court, and upon Part E of this Scheme becoming effective in accordance with the terms hereof. For this purpose, the Amalgamated Company may file appropriate applications/documents with relevant authorities concerned for information and record purposes. However, it is hereby clarified that the absence of any such substitution/endorsement shall not adversely affect the rights, benefits or interest of the Amalgamated Company which shall be deemed to have been transferred to the Amalgamated Company automatically upon the Part E of the Scheme becoming effective on the Effective Date.
- (ix) Upon Part E of the Scheme coming into effect on the Effective Date and with effect from the Appointed Date, immediately after giving effect to Part B of the Scheme, all workmen and employees of the Amalgamating Company No. 3, who are on its payrolls and all respective other personnel employed by the Amalgamating Company No. 3 shall become employed by the Amalgamated Company with effect from the Effective Date, on such terms and conditions as are no less favourable than those on which they were engaged with the Amalgamating Company No. 3, immediately prior to the Effective Date, without any interruption of service as a result of this amalgamation and transfer. With regard to provident fund, gratuity fund, superannuation fund and any contributions required to be made in relation to employees under any statute or regulation, leave encashment and any other special scheme or benefits created or existing for the benefit of the personnel employed by the Amalgamating Company No. 3, immediately prior to Part E of the Scheme coming into effect on the Effective Date and transferred to the Amalgamated Company, the Amalgamated Company shall stand substituted for the Amalgamating Company No. 3 for all intents and purposes whatsoever, upon Part E of this Scheme becoming effective on the Effective Date, including with regard to the obligation to make contributions to the said funds in accordance with the provisions of such schemes or funds in the respective trust deeds or other documents and/or in accordance with the provisions of Applicable Laws or otherwise. All respective existing contributions made to such schemes and funds and all benefits accrued thereto shall also stand transferred in the name of the Amalgamated Company and all such benefits and schemes shall be continued by the Amalgamated Company for the benefit of such personnel employed by the Amalgamating Company No. 3 and transferred to the Amalgamated Company, on the same terms and conditions. Further, it is the aim and intent of the Scheme that all rights, duties, powers and obligations of the Amalgamating Company No. 3 in relation to such schemes or funds shall become those of the Amalgamated Company. It is clarified that the services of all

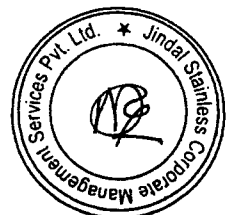
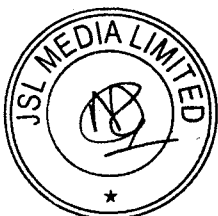
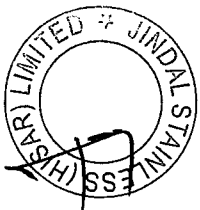
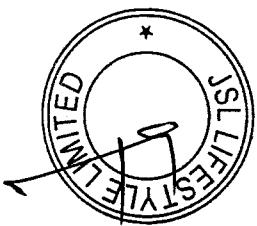

personnel employed by the Amalgamating Company No. 3 who are entitled to the benefits under such schemes and funds, will be treated as having been continuous and uninterrupted for the purpose of the aforesaid schemes or funds.

- (x) Upon Part E of the Scheme coming into effect on the Effective Date, immediately after giving effect to Part B of the Scheme, the Amalgamated Company undertakes to continue to abide by any agreement(s)/settlement(s) entered into with any labour unions/employees by the Amalgamating Company No. 3. The Amalgamated Company agrees that for the purpose of payment of any future retrenchment compensation, gratuity and other terminal benefits, the past services of such employees, if any, with the Amalgamating Company No. 3 shall also be taken into account, and agrees and undertakes to pay the same as and when payable. Further, upon Part E of the Scheme coming into effect on the Effective Date, immediately after giving effect to Part B of the Scheme, any prosecution or disciplinary action initiated, pending or contemplated against and any penalty imposed in this regard on any employee by the Amalgamating Company No. 3 shall be continued or shall continue to operate against the relevant employee and shall be enforced effectively by the Amalgamated Company.
- (xi) Upon Part E of the Scheme coming into effect on the Effective Date and with effect from the Appointed Date, immediately after giving effect to Part B of the Scheme, all rights, entitlements, licenses, applications and registrations relating to trademarks, service marks, copyrights, domain names, brand name, logos, patents and other intellectual property rights of every kind and description, including without limitations, whether registered, unregistered or pending registration, and the goodwill arising therefrom, if any, to which the Amalgamating Company No. 3 is a party or to the benefit of which the Amalgamating Company No. 3 may be eligible or entitled, shall stand transferred to and vested in the Amalgamated Company, and shall become the rights, entitlement or property of the Amalgamated Company and shall be enforceable by or against the Amalgamated Company, as fully and effectually as if, instead of the Amalgamating Company No. 3 the Amalgamated Company had been a party or beneficiary or obligee thereto or the holder or owner thereof, without any further act, instrument or deed required from the Amalgamating Company No. 3 and/or the Amalgamated Company and without any approval or acknowledgement of any third party.
- (xii) Upon Part E of the Scheme coming into effect on the Effective Date and with effect from the Appointed Date, immediately after giving effect to Part B of the Scheme, the Amalgamated Company shall be entitled to the benefit of all respective insurance policies (if any) which have been issued in respect of the Amalgamating Company No. 3 and/or any of its assets or employees and the name of the Amalgamated Company shall stand substituted as the "Insured" in all such policies as if the Amalgamated Company was originally a party thereto without any further act, instrument or deed required from the Amalgamating Company No. 3 and/or the Amalgamated Company and without any approval or acknowledgement of any third party. Further, the Amalgamated Company shall be entitled to the benefit of all claims filed, prosecuted, proposed to be filed, pending and/or adjudicated in relation to all insurance policies issued in respect of Amalgamating Company No. 3 and/or any of its assets or employees, as the case may be.
- (xiii) Upon Part E of the Scheme coming into effect on the Effective Date and with effect from the Appointed Date, immediately after giving effect to Part B of the Scheme, all taxes and duties of whatsoever description ((including but not limited all carry forward tax losses comprising of unabsorbed depreciation, advance tax payments, TDS, TCS, MAT, securities transaction tax, taxes withheld/paid in a foreign country, customs duty, entry tax, value added tax, GST, sales tax, service tax etc.) payable by or refundable to the Amalgamating Company No. 3, including all or any refunds or claims shall be treated as the tax liability or refunds/claims, as the case may be, of the Amalgamated Company, and any tax incentives, advantages, privileges, exemptions, credits, holidays, remissions, reductions etc., as would have been available to the Amalgamating Company No. 3 shall

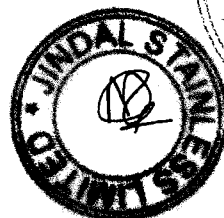
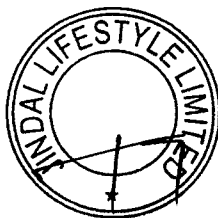
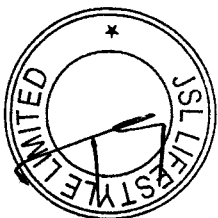
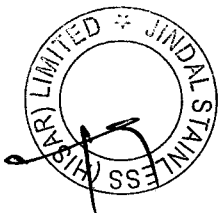
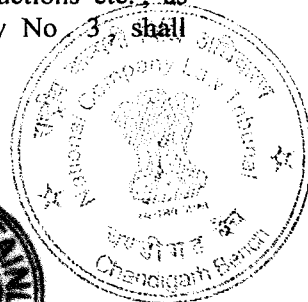
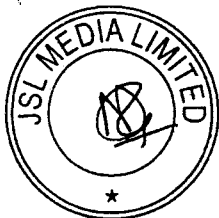

pursuant to this Scheme becoming effective, be available to the Amalgamated Company without any further act, instrument or deed required from the Amalgamating Company No. 3 and/or the Amalgamated Company and without any approval or acknowledgement of any third party but in the manner more particularly set out herein below. Upon Part E of the Scheme coming into effect on the Effective Date and with effect from the Appointed Date, immediately after giving effect to Part B of this Scheme, all existing and future incentives, un-availed credits and exemptions, benefit of carried forward losses and other statutory benefits, including in respect of income tax (including MAT), excise (including Modvat/Cenvat), customs, value added tax, sales tax, service tax to which the Amalgamating Company No. 3 is entitled shall be available to and shall stand transferred and vested in the Amalgamated Company without any further act, instrument or deed required on part of the Amalgamated Company or on part of the Amalgamating Company No. 3, without any approval or acknowledgement of any third party. Upon Part E of the Scheme coming into effect on the Effective Date and with effect from the Appointed Date, any tax deducted at source deducted by or on behalf of the Amalgamating Company No. 3 until the Effective Date shall be deemed to have been deducted on behalf of the Amalgamated Company.

- (xiv) Upon Part E of the Scheme coming into effect on the Effective Date and with effect from the Appointed Date, immediately after giving effect to Part B of the Scheme, the Amalgamated Company shall be entitled to claim the benefit of any and all corporate approvals and limits as may have already been taken by the Amalgamating Company No. 3, including without limitation, the approvals and limits under Sections 62, 179, 180, 185, 186, 188 etc., of the Act, until the time the same are duly modified by the Amalgamated Company.
- (xv) Upon Part E of the Scheme coming into effect on the Effective Date and with effect from the Appointed Date, immediately after giving effect to Part B of the Scheme, all other estates, assets, rights, title, interests and authorities accrued to and/or acquired by the Amalgamating Company No. 3 shall be deemed to have been accrued to and/or acquired for and on behalf of the Amalgamated Company and shall, upon Part E of this Scheme coming into effect, pursuant to the provisions of the Act, without any further act, instrument or deed be and stand transferred to or vested in and/or be deemed to have been transferred to or vested in the Amalgamated Company to that extent and shall become the estates, assets, right, title, interests and authorities of the Amalgamated Company.
- (xvi) Upon Part E of the Scheme coming into effect on the Effective Date immediately after giving effect to Part B of this Scheme, all books, record files, papers, computer programs, engineering and process information, manuals, data, production methodologies, production plans, designs, catalogues, quotations, websites, cloud storage, sales and advertising material, marketing strategies, list of present and former customers, customer credit information, customer pricing information, and other records whether in physical form or electronic form or in any other form in connection with or relating to the Amalgamating Company No. 3 shall be deemed to have been transferred to or acquired for and on behalf of the Amalgamated Company and shall, upon Part E of this Scheme coming into effect, without any further act, instrument or deed be and stand transferred to or vested in and/or be deemed to have been transferred to or vested in the Amalgamated Company.
- (xvii) Upon Part E of the Scheme coming into effect on the Effective Date and with effect from the Appointed Date, immediately after giving effect to Part B of the Scheme, the Amalgamated Company shall bear the burden and the benefits of any legal, tax, quasi-judicial, administrative, regulatory or other proceedings initiated by or against the Amalgamating Company No. 3. If any suit, appeal or other proceeding of whatsoever nature by or against the Amalgamating Company No. 3 shall be pending as on the Effective Date, the same shall not abate, be discontinued or in any way be prejudicially affected by reason of the merger of such Amalgamating Company No. 3 and transfer and vesting of the same in the Amalgamated Company or of anything contained in Part E of this Scheme but the proceedings may be continued, prosecuted and enforced by or against

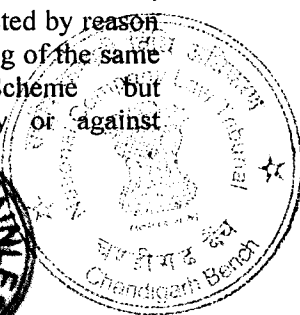
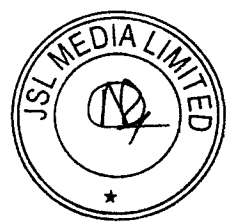
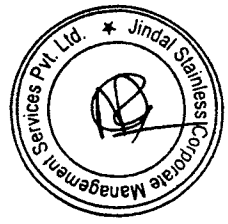
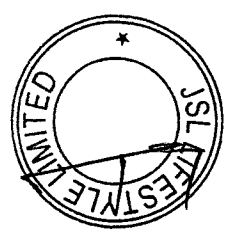
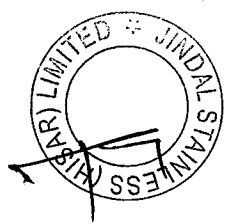
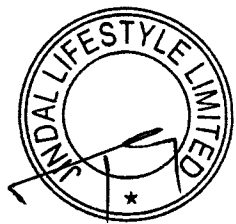

the Amalgamated Company in the same manner and to the same extent as it would or might have been continued, prosecuted and enforced by or against the Amalgamating Company No. 3, as if Part E of this Scheme had not been made effective. Upon Part E of the Scheme becoming effective, the Amalgamated Company undertakes to have such legal or other proceedings initiated by or against the Amalgamating Company No. 3 transferred in its name and to have the same continued, prosecuted and enforced by or against the Amalgamated Company to the exclusion of the Amalgamating Company No. 3. The Amalgamated Company also undertakes to handle all legal or other proceedings which may be initiated against the Amalgamating Company No. 3 after the Effective Date in its own name and account and further undertakes to pay all amounts including interest, penalties, damages etc., pursuant to such legal/ other proceedings.

38.3 Upon Part E of the Scheme coming into effect on the Effective Date with effect from the Appointed Date, immediately after giving effect to Part B of the Scheme, the Amalgamated Company shall be entitled to the benefit of the past experience, accreditation, and/or performance of the Amalgamating Company No. 3 for all purposes without any further act, instrument or deed required on the part of the Amalgamating Company No. 3 or on the part of the Amalgamated Company and without any approval or acknowledgement being required from any third party. If any instrument or deed or document is required or deemed necessary or expedient to give effect to the provisions of this Clause by the Amalgamated Company, the Amalgamated Company shall, under the provisions of Part E of the Scheme, be deemed to be duly authorized to execute all such writings on behalf of the Amalgamating Company No. 3, to carry out or perform all such formalities or compliances referred to above on behalf of the Amalgamating Company No. 3.

39 AMENDMENT TO OBJECTS OF THE AMALGAMATED COMPANY

39.1 Upon Part E of the Scheme becoming effective from the Effective Date immediately after giving effect to Part B of this Scheme, the following sub-clause shall be deemed to have been automatically added to Clause III (A) (Main Objects) of the Memorandum of Association of the Amalgamated Company immediately after the existing sub-clauses of Clause III (A) and the "Objects Clause" in the Memorandum of Association of the Amalgamated Company shall be deemed to have been amended to that extent by inserting below clauses in the main objects of the Amalgamated Company:-

"1. To carry on business of advertising, publicity, public relations, media management, producing, promoting, researching and designing, communications in a variety of media (a) printing and publishing, (b) exhibition display, (c) audio, (d) video, (e) film (motion pictures and still photography.) either directly or through agents and contractors."

39.2 It is hereby clarified that the consent of the shareholders of the Amalgamated Company and shareholders of the Amalgamating Companies to Part E of this Scheme shall be sufficient for the purposes of effecting the aforesaid amendments in the "Objects Clause" in the Memorandum of Association of the Amalgamated Company and that no further resolutions, under the applicable provisions of the Act, shall be required to be separately passed. All actions taken in accordance with this Clause shall be deemed to be in full compliance of Section 13 and other applicable provisions of the Act and rules and regulations issued thereunder and no further resolutions or actions under any other provisions of the Act or the rules or regulations issued thereunder would be required to be separately passed or undertaken by the Amalgamated Company.

CONDUCT OF AFFAIRS UNTIL THE EFFECTIVE DATE

40.1 In the event Part E of this Scheme becomes effective and with effect from the Appointed Date and up to and including the Effective Date:

(i) the Amalgamating Company No. 3 shall be deemed to have carried on the business

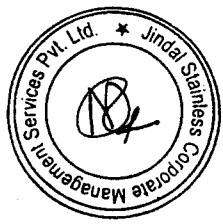
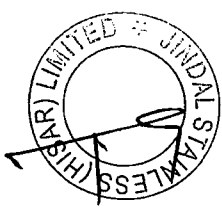
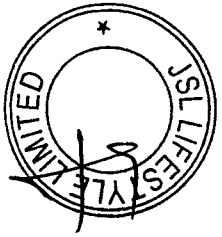
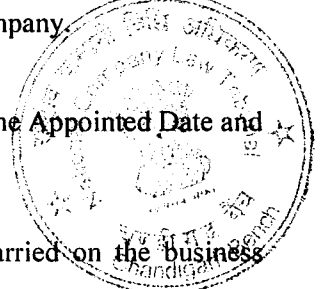

262

activities of the Amalgamating Company No. 3 stand possessed of the properties and assets of the Amalgamating Company No. 3, for, on behalf of and in trust for, the Amalgamated Company; and

- (ii) all profits or income accruing to or received by the Amalgamating Company No. 3 all taxes paid thereon (including but not limited to advance tax, tax deducted at source, tax collected at source, minimum alternate tax, fringe benefit tax, securities transaction tax, taxes withheld/paid in a foreign country, customs duty, entry tax, value added tax, goods and services tax, sales tax, service tax etc.) or losses arising in or incurred by the Amalgamating Company No. 3 shall, for all purposes, be treated as and deemed to be the profits, income, taxes or losses, as the case may be, of the Amalgamated Company.

40.2 The Amalgamated Company shall also be entitled, pending the sanction of this Scheme, to apply to the central government, state government, and all other agencies, departments, statutory authorities and Governmental Authorities concerned, wherever necessary, for such consents, approvals and sanctions which the Amalgamated Company may require including the registration, approvals, exemptions, reliefs, etc., as may be required/granted under any Applicable Law for the time being in force for carrying on the business of the Amalgamating Company No. 3.

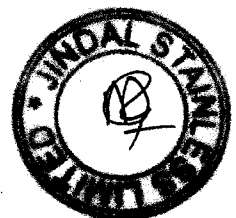
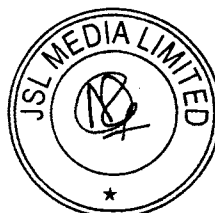
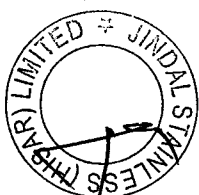
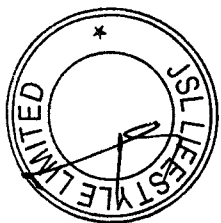

41 TREATMENT OF TAXES

41.1 Upon Part E of this Scheme becoming effective and with effect from the Appointed Date immediately after giving effect to Part B of this Scheme, any surplus in the provision for taxation/ duties/ levies account including but not limited to the advance tax, TDS or TCS and MAT credit, CENVAT credit, GST Credit, as on the date immediately preceding the Appointed Date will also be transferred from the Amalgamating Company No. 3 to the Amalgamated Company. Any refund under the IT Act or other Applicable Laws dealing with taxes/ duties/ levies, including GST, allocable or related to the business of Amalgamating Company No. 3 a or due to the Amalgamating Company No. 3 consequent to the assessment made in respect of the Amalgamating Company No. 3, for which no credit is taken in the books of accounts of the Amalgamating Company No. 3 as on the date immediately preceding the Appointed Date, shall also belong to and be received by Amalgamated Company and shall be deemed to have been on account of or paid by the Amalgamated Company and the relevant Governmental Authorities shall be bound to transfer to the account of and give credit for the same to the Amalgamated Company upon the approval of this Scheme by the Court and upon relevant proof and documents being provided to the said Governmental Authorities.

41.2 Without prejudice to the generality of the above, deductions, benefits, right to carry forward and set off accumulated losses and unabsorbed depreciation, and credits (including but not limited to MAT/CENVAT credits etc.) under the IT Act, Goods and Services Tax or Service Tax, any central government/state government incentive schemes etc., to which the Amalgamating Company No. 3 is / would be entitled to in terms of the Applicable Tax Laws of the central and state government or of any foreign jurisdictions, shall be available to and vest in the Amalgamated Company.

41.3 Upon Part E of this Scheme becoming effective and with effect from the Appointed Date immediately after giving effect to Part B of this Scheme, the tax payments (including without limitation income tax, GST, tax on distribution of dividends, excise duty, central sales tax, custom duty, applicable state value added tax and entry tax or any other taxes as may be applicable from time to time) whether by way of TDS or TCS, advance tax or otherwise howsoever, by the Amalgamating Company No. 3 on or after the Appointed Date, shall be deemed to be paid by the Amalgamated Company and the Amalgamated Company shall be entitled to claim credit for such taxes/duties paid against its tax/ duty liabilities, notwithstanding that the certificates/ challans or other documents for payment of such taxes/duties are in the name of Amalgamating Company No. 3.

41.4 Upon Part E of the Scheme becoming effective on the Effective Date, with effect from the Appointed Date immediately after giving effect to Part B of this Scheme, the Amalgamating Company No. 3 and the Amalgamated Company are expressly permitted to prepare and/or revise, as the case may be, their financial statements and statutory / Tax returns along with the prescribed forms, filings and annexures under the IT Act and/or in relation to central sales tax, custom duty, entry tax, applicable state value added tax, GST and other tax laws, if required, to give effect to the provisions of the Scheme.

Upon Part E of the Scheme becoming effective on the Effective Date, with effect from the Appointed Date immediately after giving effect to Part B of this Scheme, all inter-party transactions between Amalgamating Company No. 3 and the Amalgamated Company shall be considered as intra-party transactions for all purposes (including for tax compliances, credits, refunds, etc.).

41.6 Upon Part E of the Scheme becoming effective on the Effective Date, with effect from the Appointed Date immediately after giving effect to Part B of this Scheme, obligation for deduction of tax at source on any payment made by or to be made by the Amalgamating Company No. 3 or for collection of tax at source on any supplies made by or to be made by Amalgamating Company No. 3 shall be made or deemed to have been made and duly complied with by the Amalgamated Company. Further, any tax deducted at source or collected at source by the Amalgamating Company No. 3 and Amalgamated Company on transactions with each other, if any (from the

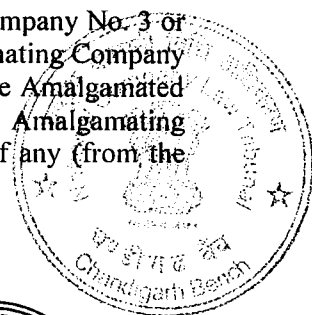
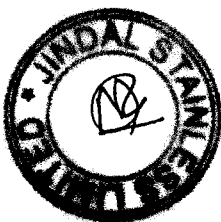
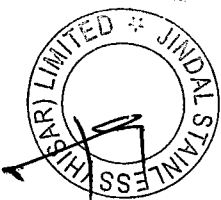
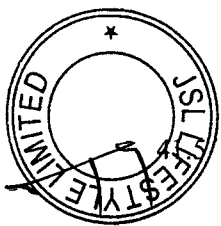

264

Appointed Date until Effective Date) and deposited with the Governmental Authorities shall be deemed to be advance tax paid by the Amalgamated Company and shall, in all proceedings be dealt with accordingly.

- 41.7 Upon Part E of the Scheme becoming effective on the Effective Date, with effect from the Appointed Date immediately after giving effect to Part B of this Scheme, all tax compliances under any tax laws by the Amalgamating Company No. 3 on or after the Appointed Date shall be deemed to be made by the Amalgamated Company.
- 41.8 Upon Part E of the Scheme becoming effective on the Effective Date, with effect from the Appointed Date immediately after giving effect to Part B of this Scheme, all tax assessment proceedings and appeals of whatsoever nature by or against the Amalgamating Company No. 3, pending or arising as at the Effective Date, shall be continued and/enforced by or against the Amalgamated Company in the same manner and to the same extent as would or might have been continued and enforced by or against the Amalgamating Company No. 3. Further, the aforementioned proceedings shall neither abate or be discontinued nor be in any way prejudicially affected by the reason of the amalgamation of the Amalgamating Company No. 3 with the Amalgamated Company or anything contained in Part E of this Scheme.
- 41.9 Upon Part E of the Scheme becoming effective on the Effective Date, with effect from the Appointed Date immediately after giving effect to Part B of this Scheme, all the expenses incurred by the Amalgamating Company No. 3 and the Amalgamated Company in relation to the amalgamation of the Amalgamating Company No. 3 with the Amalgamated Company as per Part E of this Scheme, including stamp duty expenses and / or transfer charges, if any, shall be allowed as deduction to Amalgamated Company in accordance with Section 35DD of the IT Act over a period of 5 (five) years beginning with the previous year in which Part E of the Scheme becomes effective.
- 41.10 With effect from the Appointed Date, all the deductions otherwise admissible to the Amalgamating Company No. 3, including payment admissible on actual payment or on deduction of appropriate taxes or on payment of TDS (like Section 43B, Section 40, Section 40A etc. of the IT Act) will be eligible for deduction to the Amalgamated Company upon fulfilment of required conditions under the IT Act.
- 41.11 The amalgamation under this Scheme is in compliance with the IT Act, specifically Section 2(1B) and other relevant provisions. If any of the terms of this Scheme are inconsistent with the provisions of Sections 2(1B) of the IT Act, the provisions of Sections 2(1B) of the IT Act shall to the extent of such inconsistency, prevail and this the Scheme shall, stand and be deemed to be modified to that extent to comply with the said provisions and such modifications shall not affect the other Parts of this Scheme.

42 CONDUCT OF AFFAIRS AFTER THE EFFECTIVE DATE

- 42.1 The Amalgamated Company, shall, at any time after Part E of this Scheme becomes effective on the Effective Date immediately after giving effect to Part B of this Scheme, in accordance with the provisions hereof, if so required under any law, contract or otherwise, be entitled to do and take all such actions as may be required to give full effect to the provisions of this Part E and for this purpose the Amalgamated Company shall, under the provisions hereof, be deemed to be authorised on behalf of the Amalgamating Company No. 3. Without prejudice to the generality of the above, the Amalgamated Company shall be entitled and deemed to be authorised to:-

- (i) execute appropriate deeds of confirmation or other writings or arrangements with any party to any contract or arrangement (including without limitation any bank guarantee, performance guarantee, fixed deposit, letters of credit, bill of entry etc.) in relation to which the Amalgamating Company No. 3 have been a party or to the benefit of which the Amalgamating Company No. 3 may have been entitled, and to make any filings with the regulatory authorities, in order to give formal effect to the provisions of Part E of the

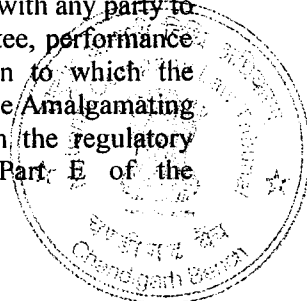
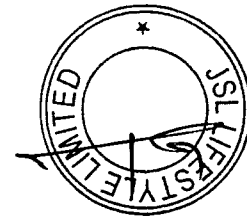
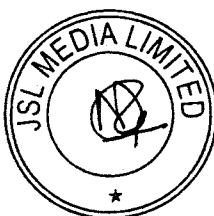
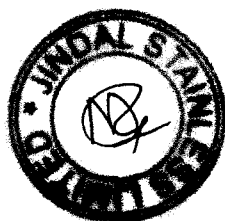
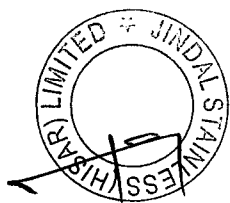

265

Scheme; and

- (ii) do all such acts or things as may be necessary to effectually transfer/obtain in favour of the Amalgamated Company the approvals, consents, bids, awards, tenders, exemptions, registrations, no-objection certificates, permits, quotas, rights, entitlements, licenses and certificates etc. which were held or enjoyed by the Amalgamating Company No. 3 including without limitation, execute all necessary or desirable writings and confirmations on behalf of the Amalgamating Company No. 3 to carry out and perform all such acts, formalities and compliances as may be required in this regard.

42.2 The provisions of this Clause shall operate notwithstanding anything to the contrary contained in any deed or writing or certificate or license or the terms of sanction or issue or any security, all of which instruments and documents shall stand modified and/or superseded by the foregoing provisions.

43 SAVING OF CONCLUDED TRANSACTIONS

Except as expressly provided hereunder including in Clause 41.4 and Clause 41.5, the transfer of properties and liabilities to, and the continuance of proceedings by or against, the Amalgamated Company as envisaged in this Part E shall not affect any transaction or proceedings already concluded by the Amalgamating Company No. 3 on or before the Appointed Date and after the Appointed Date and until the Effective Date, and to such end and intent the Amalgamated Company accepts and adopts all acts, deeds and things done and executed by the Amalgamating Company No. 3 in respect thereto as done and executed on behalf of itself.

44 DISCHARGE OF CONSIDERATION

- 44.1 Upon Part B of the Scheme coming into effect on the Effective Date, Amalgamating Company No. 3 which is currently a wholly owned subsidiary of Amalgamating Company No. 1 will become a wholly owned subsidiary of the Amalgamated Company, hence no further shares of the Amalgamated Company will be issued upon the amalgamation of the Amalgamating Company No. 3 with the Amalgamated Company.
- 44.2 The Board of Directors (including any committee thereof) of Amalgamating Company No. 3 shall be empowered to remove such difficulties as may arise in the course of implementation of this Scheme.

45 DISSOLUTION OF AMALGAMATING COMPANY NO. 3

- 45.1 Upon Part E of this Scheme becoming effective on the Effective Date immediately after giving effect to Part B of this Scheme, the Amalgamating Company No. 3 shall stand automatically dissolved as an integral part of this Scheme, without being liquidated or wound-up and without requiring any further act, instrument or deed from the Amalgamating Company No. 3 and/or the Amalgamated Company.

ACCOUNTING TREATMENT

Upon Part E of the Scheme becoming effective, with effect from the Appointed Date, the Amalgamated Company shall account for the amalgamation in its books of accounts, as per 'Acquisition Method' in accordance with accounting principles as laid down in Ind AS-103 notified under Section 133 of the Act and under the Companies (Indian Accounting Standards) Rules, 2015, as may be amended from time to time, such that:

- (i) In line with the recognition principles provided under Indian Accounting Standard

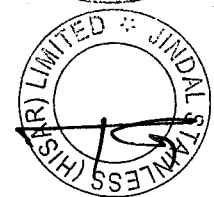
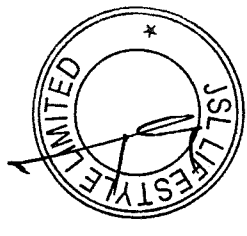
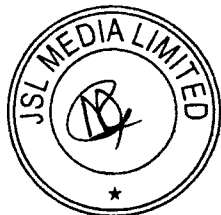
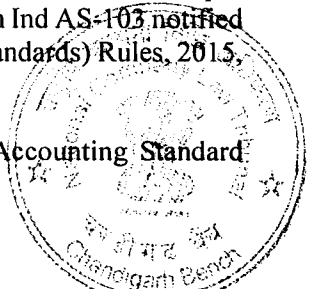
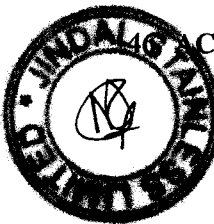

266

103 on Business Combinations, the Amalgamated Company shall recognise all assets and liabilities of the Amalgamating Company No. 3 transferred to and vested in the Amalgamated Company pursuant to this Scheme at their respective fair values as on the Appointed Date. Such assets may also include acquired identifiable intangible assets, whether previously recorded in the books of accounts of the Amalgamating Company No. 3 or not. Upon Part E of the Scheme coming into effect, the above recognition shall result in the Amalgamated Company recording all the assets and liabilities of the Amalgamating Company No. 3 transferred to and vested in it pursuant to this Scheme.

- (ii) Investment held by Amalgamating Company No. 1 in the Amalgamating Company No. 3 shall be cancelled.
- (iii) Inter-company balances between the Amalgamated Company and the Amalgamating Company No. 3, if any, shall stand cancelled and there shall be no further obligation in that behalf.
- (iv) Excess, if any, of investment cancelled as per sub-Clause (ii) above the fair value of net assets taken over as per sub-Clause (i) above, after giving the effect to sub-Clause (iii) above, shall be recorded as goodwill. In case of deficit, it shall be credited to capital reserve account.

PART F
AMALGAMATION OF AMALGAMATING COMPANY NO. 4 INTO AND WITH THE AMALGAMATED COMPANY

47 AMALGAMATION OF AMALGAMATING COMPANY NO. 4 INTO AND WITH THE AMALGAMATED COMPANY

47.1 Subject to the provisions of Part F and Part G of this Scheme in relation to the modalities of amalgamation, upon Part F of this Scheme becoming effective on the Effective Date and with effect from the Appointed Date, immediately after giving effect to Part B of the Scheme, the Amalgamating Company No. 4 along with all its assets, liabilities, rights and obligations and its entire business and undertakings, together with all their respective properties, rights, benefits and interests therein, shall by virtue of this Part F of the Scheme stand amalgamated with, transferred to and vested in the Amalgamated Company, and in each case shall become the assets, liabilities, rights, obligations, business and undertakings of the Amalgamated Company, subject to the existing encumbrances thereon in favour of banks and financial institutions, if any (unless otherwise agreed to by such encumbrance holders), without any further act, instrument or deed being required on the part of the Amalgamating Company No. 4, and/or on the part of the Amalgamated Company and without any approval or acknowledgement of any third party, in accordance with Sections 230 to 232 of the Act read with Section 2(1B) of the IT Act and all other applicable provisions of law if any, in accordance with the provisions contained herein.

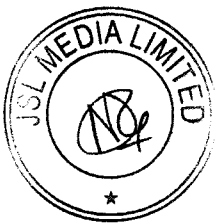

47.2 Without prejudice to the generality of the above, in particular, the Amalgamating Company No. 4, shall stand amalgamated with the Amalgamated Company in the manner described in the subparagraphs below, subject to the existing encumbrances in favour of banks and financial institutions, if any (unless otherwise agreed to by such encumbrance holders):-

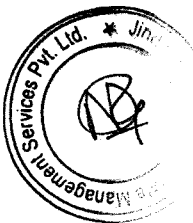

- (i) Upon Part F of this Scheme becoming effective on the Effective Date and with effect from the Appointed Date, immediately after giving effect to Part B of this Scheme, all the respective assets (including investments) of the Amalgamating Company No. 4, that are movable in nature or incorporeal or intangible in nature or are otherwise capable of

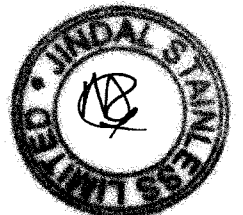
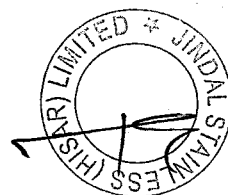
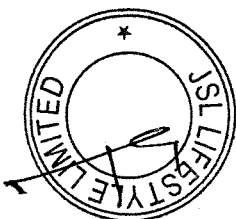
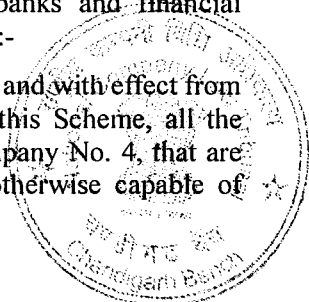

transfer by physical or constructive delivery and/or by endorsement and delivery or by transfer or by delivery instructions in relation to dematerialized shares or by vesting and recordal pursuant to the Scheme, including plant, machinery and equipment, shall stand transferred to and vested in and/or be deemed to be transferred to and vested in the Amalgamated Company and shall become the property and an integral part of the Amalgamated Company, without any further act, instrument or deed required from the Amalgamating Company No. 4 and/or the Amalgamated Company and without any approval or acknowledgement of any third party. The transfer and vesting pursuant to this sub-clause shall be deemed to have occurred by physical or constructive delivery or by endorsement and delivery or by delivery instructions in relation to dematerialized shares or by vesting and recordal, pursuant to this Scheme, as appropriate to the property being transferred and vested and the title to such property shall be deemed to have been transferred and vested accordingly.

(ii) Upon Part F of this Scheme becoming effective on the Effective Date and with effect from the Appointed Date, immediately after giving effect to Part B of this Scheme, any and all other movable properties of the Amalgamating Company No. 4 (except those specified elsewhere in this Clause), including cash and cash equivalents, sundry debts and receivables, outstanding loans and advances, if any, recoverable in cash or in kind or for value to be received, actionable claims, bank balances and deposits, if any, with any person or body including without limitation any government, semi-government, local and other authorities and bodies, customers and other persons shall, without any further act, instrument or deed required from the Amalgamating Company No. 4 and/or the Amalgamated Company and without any approval or acknowledgement of any third party, become the property of the Amalgamated Company.

(iii) Upon Part F of this Scheme becoming effective on the Effective Date and with effect from the Appointed Date, immediately after giving effect to Part B of this Scheme, all immovable properties of the Amalgamating Company No. 4, including without limitations, all land together with all buildings and structures standing thereon and all rights and interests therein, whether freehold or leasehold or otherwise and all documents of title, rights and easements in relation thereto shall stand transferred and be vested in and/or be deemed to have been transferred vested in the Amalgamated Company and shall become the property and an integral part of the Amalgamated Company, without any further act, instrument or deed being required from the Amalgamating Company No. 4, and/or the Amalgamated Company and without any approval or acknowledgement of any third party. Upon Part F of the Scheme becoming effective on the Effective Date, immediately after giving effect to Part B of this Scheme, the Amalgamated Company shall be entitled to exercise all rights and privileges attached to the aforesaid immovable properties and shall be liable to pay all rent, charges and taxes and fulfil all obligations in relation to or applicable to such immovable properties of the Amalgamating Company No. 4. The Amalgamated Company shall be entitled to seek mutation/substitution of title in its name in such immovable properties, for the purposes of information and record and such mutation / substitution of the title to and interest in such immovable properties shall be made and duly recorded in the name of the Amalgamated Company, by the appropriate authorities pursuant to the sanction of the Scheme by the Court and Part F of the Scheme becoming effective on the Effective Date, immediately after giving effect to Part B of the Scheme, in accordance with the terms hereof. However, it is hereby clarified that the absence of any such mutation/substitution shall not adversely affect the rights, title or interest of the Amalgamated Company in such immovable properties which shall be deemed to have been transferred to the Amalgamated Company automatically upon the Part F of the Scheme becoming effective on the Effective Date immediately after giving effect to Part B of this Scheme.

(iv) Upon Part F of this Scheme becoming effective on the Effective Date and with effect from the Appointed Date, immediately after giving effect to Part B of this Scheme, all

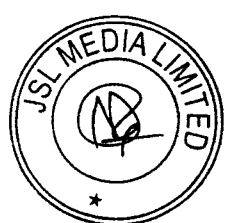
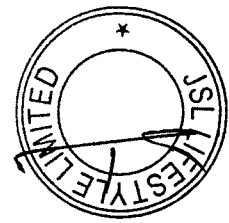
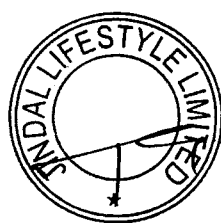
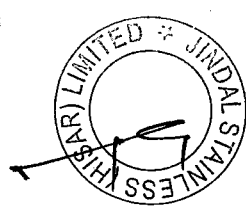
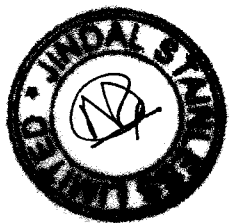
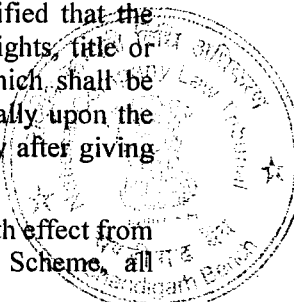

debts, liabilities, contingent liabilities, duties and obligations, secured or unsecured, whether provided for or not in the books of accounts of the Amalgamating Company No. 4, disclosed in the balance sheets of the Amalgamating Company No. 4, shall become and be deemed to be the debts, liabilities, contingent liabilities, duties and obligations of the Amalgamated Company without any further act, instrument or deed being required from the Amalgamating Company No. 4 and/or the Amalgamated Company and without any approval or acknowledgement of any third party. The Amalgamated Company undertakes to meet, discharge and satisfy the same in terms of their respective terms and conditions, if any. It is hereby clarified that it shall not be necessary to obtain the consent of any third party or other person, who is a party to any contract or arrangement by virtue of which such debts, liabilities, duties and obligations have arisen in order to give effect to the provisions of this sub-clause. However, the Amalgamated Company shall, if required, file appropriate forms with the RoC accompanied by the sanction order of the Court or a certified copy thereof and execute necessary deeds or documents in relation to creation/satisfaction/modification of charges to the satisfaction of the lenders, pursuant to Part F of this Scheme becoming effective, immediately after giving effect to Part B of the Scheme, in accordance with the terms hereof. The Amalgamated Company shall be entitled to take the benefit of all duties and charges already paid by the Amalgamating Company No. 4 for the creation/modification of any such security interest. Where any of the loans, liabilities and obligations have been discharged by the Amalgamating Company No. 4, after the Appointed Date but before the Effective Date, such discharge shall be deemed to have been done by the Amalgamating Company No. 4, for and on behalf of the Amalgamated Company.

- (v) Upon Part F of this Scheme becoming effective on the Effective Date and with effect from the Appointed Date, immediately after giving effect to Part B of this Scheme, all loans, advances, trade receivables and other obligations or liabilities due from, or any guarantees or similar obligations undertaken on behalf of the Amalgamating Company No. 4 to / by the Amalgamated Company or *vice versa*, if any, and all contracts between the Amalgamating Company No. 4, with the Amalgamated Company shall stand automatically cancelled and terminated and shall be of no effect, without any further act, instrument or deed being required by either the Amalgamating Company No. 4, or the Amalgamated Company and without any approval or acknowledgement of any third party. No further taxes, fees, duties or charges shall be required to be paid by the Amalgamated Company on account of such cancellation or termination.
- (vi) Upon Part F of the Scheme coming into effect on the Effective Date and with effect from the Appointed Date, immediately after giving effect to Part B of this Scheme, all incorporeal or intangible property of or in relation to the Amalgamating Company No. 4 shall stand transferred to and vested in the Amalgamated Company, and shall become the property and an integral part of the Amalgamated Company without any further act, instrument or deed required by either the Amalgamating Company No. 4 or the Amalgamated Company and without any approval or acknowledgement of any third party.
- (vii) Upon Part F of the Scheme coming into effect on the Effective Date and with effect from the Appointed Date, immediately after giving effect to Part B of this Scheme, all letters of intent, memoranda of understanding, memoranda of agreements, tenders, bids, letters of award, expressions of interest, experience and/or performance statements, contracts, deeds, bonds, agreements, guarantees and indemnities, schemes, arrangements, undertakings and respective other instruments of every nature and description including without limitation, those relating to the respective tenancies, privileges, powers and facilities of every kind and description, to which the Amalgamating Company No. 4 is a party or to the benefit of which the Amalgamating Company No. 4 may be eligible or under which the Amalgamating Company No. 4 is an obligor (except to the extent provided in this Clause) and which are subsisting or having effect immediately prior to

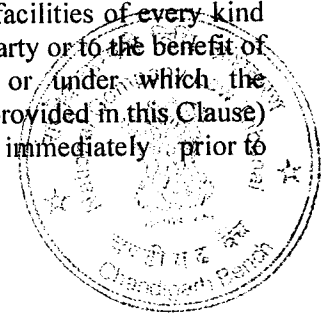
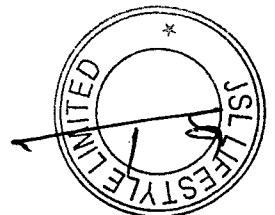
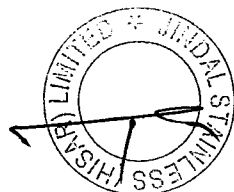
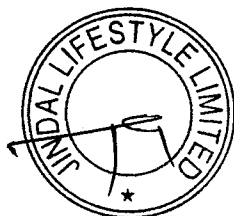
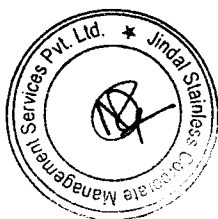
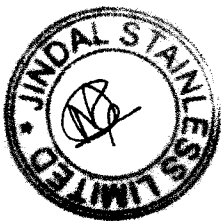
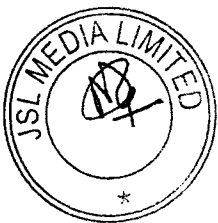

Part F of the Scheme coming into effect on the Effective Date, shall be and shall remain in full force and effect against or in favour of the Amalgamated Company and may be enforced by or against it as fully and effectually as if, instead of the Amalgamating Company No. 4, the Amalgamated Company had been a party or beneficiary or obligee or obligor thereto, without any further act, instrument or deed being required from the Amalgamating Company No. 4 and/or the Amalgamated Company and without any approval or acknowledgement of any third party.

(viii) Upon Part F of the Scheme coming into effect on the Effective Date and with effect from the Appointed Date, immediately after giving effect to Part B of this Scheme, all statutory or regulatory licenses and permits including without limitation, all such licenses and permits, grants, allotments, recommendations, no-objection certificates, permissions, registrations, approvals, certificates, consents, quotas, exemptions, clearances, tenancies, privileges, powers, offices, facilities, entitlements or rights granted/available/renewed/applied for, to or by the Amalgamating Company No. 4 shall stand transferred to and vested in the Amalgamated Company, without any further act, instrument or deed being required from the Amalgamating Company No. 4 and/or the Amalgamated Company and without any approval or acknowledgement of any third party. Upon Part F of the Scheme coming into effect on the Effective Date, immediately after giving effect to Part B of the Scheme, the Amalgamated Company shall be entitled to all the benefits thereof, and shall be liable for all the obligations thereunder. In relation to the same, any procedural requirements required to be fulfilled solely by the Amalgamating Company No. 4 (and not by any of their successors), shall be fulfilled by the Amalgamated Company as if it is the duly constituted attorney of the Amalgamating Company No. 4. It is hereby clarified that if the consent or approval (by whatever name called) of any third party or authority is required to give effect to the provisions of this Clause, the said third party or authority shall duly record provide such consent or approval and shall make the necessary substitution/endorsement in the name of the Amalgamated Company pursuant to the sanction of this Scheme by the Court, and upon Part F of this Scheme becoming effective in accordance with the terms hereof. For this purpose, the Amalgamated Company may file appropriate applications/documents with relevant authorities concerned for information and record purposes. However, it is hereby clarified that the absence of any such substitution/endorsement shall not adversely affect the rights, benefits or interest of the Amalgamated Company which shall be deemed to have been transferred to the Amalgamated Company automatically upon the Part F of the Scheme becoming effective on the Effective Date immediately after giving effect to Part B of this Scheme.

(ix) Upon Part F of the Scheme coming into effect on the Effective Date and with effect from the Appointed Date, immediately after giving effect to Part B of this Scheme, all workmen and employees of the Amalgamating Company No. 4, who are on its payrolls and all respective other personnel employed by the Amalgamating Company No. 4 shall become employed by the Amalgamated Company with effect from the Effective Date immediately after giving effect to Part B of this Scheme, on such terms and conditions as are no less favourable than those on which they were engaged with the Amalgamating Company No. 4, immediately prior to the Effective Date, without any interruption of service as a result of this amalgamation and transfer. With regard to provident fund, gratuity fund, superannuation fund and any contributions required to be made in relation to employees under any statute or regulation, leave encashment and any other special scheme or benefits created or existing for the benefit of the personnel employed by the Amalgamating Company No. 4, immediately prior to Part F of the Scheme coming into effect on the Effective Date and transferred to the Amalgamated Company, the Amalgamated Company shall stand substituted for the Amalgamating Company No. 4 for all intents and purposes whatsoever, upon Part F of this Scheme becoming effective on the Effective Date, including with regard to the obligation to make contributions to the said funds in accordance with the provisions of such schemes or funds in the respective

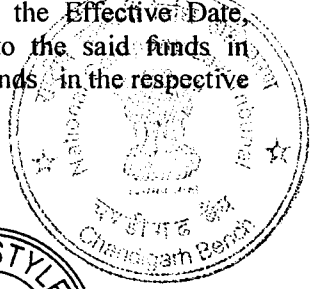
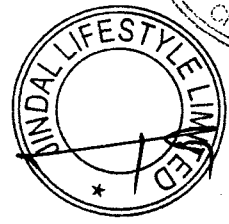
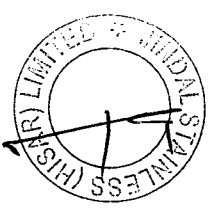
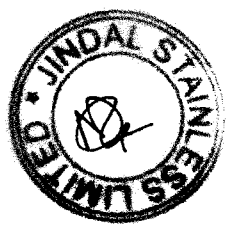
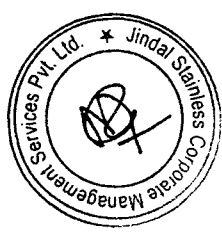
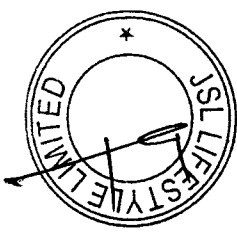

trust deeds or other documents and/or in accordance with the provisions of Applicable Laws or otherwise. All respective existing contributions made to such schemes and funds and all benefits accrued thereto shall also stand transferred in the name of the Amalgamated Company and all such benefits and schemes shall be continued by the Amalgamated Company for the benefit of such personnel employed by the Amalgamating Company No. 4 and transferred to the Amalgamated Company, on the same terms and conditions. Further, it is the aim and intent of the Scheme that all rights, duties, powers and obligations of the Amalgamating Company No. 4 in relation to such schemes or funds shall become those of the Amalgamated Company. It is clarified that the services of all personnel employed by the Amalgamating Company No. 4, who are entitled to the benefits under such schemes and funds, will be treated as having been continuous and uninterrupted for the purpose of the aforesaid schemes or funds.

(x) Upon Part F of the Scheme coming into effect on the Effective Date, immediately after giving effect to Part B of this Scheme, the Amalgamated Company undertakes to continue to abide by any agreement(s)/settlement(s) entered into with any respective labour unions/employees by the Amalgamating Company No. 4. The Amalgamated Company agrees that for the purpose of payment of any future retrenchment compensation, gratuity and other terminal benefits, the past services of such employees, if any, with the Amalgamating Company No. 4, shall also be taken into account, and agrees and undertakes to pay the same as and when payable. Further, upon Part F of the Scheme coming into effect on the Effective Date, immediately after giving effect to Part B of this Scheme, any prosecution or disciplinary action initiated, pending or contemplated against and any penalty imposed in this regard on any employee by the Amalgamating Company No. 4 shall be continued or shall continue to operate against the relevant employee and shall be enforced effectively by the Amalgamated Company.

(xi) Upon Part F of the Scheme coming into effect on the Effective Date and with effect from the Appointed Date, immediately after giving effect to Part B of this Scheme, all rights, entitlements, licenses, applications and registrations relating to trademarks, service marks, copyrights, domain names, brand name, logos, patents and other intellectual property rights of every kind and description, including without limitations, whether registered, unregistered or pending registration, and the goodwill arising therefrom, if any, to which the Amalgamating Company No. 4 is a party or to the benefit of which the Amalgamating Company No. 4 may be eligible or entitled, shall stand transferred to and vested in the Amalgamated Company, and shall become the rights, entitlement or property of the Amalgamated Company and shall be enforceable by or against the Amalgamated Company, as fully and effectually as if, instead of the Amalgamating Company No. 4, the Amalgamated Company had been a party or beneficiary or obligee thereto or the holder or owner thereof, without any further act, instrument or deed required from the Amalgamating Company No. 4, and/or the Amalgamated Company and without any approval or acknowledgement of any third party.

(xii) Upon Part F of the Scheme coming into effect on the Effective Date and with effect from the Appointed Date, immediately after giving effect to Part B of this Scheme, the Amalgamated Company shall be entitled to the benefit of all insurance policies (if any) which have been issued in respect of the Amalgamating Company No. 4 and/or any of its assets or employees and the name of the Amalgamated Company shall stand substituted as the "Insured" in all such policies as if the Amalgamated Company was originally a party thereto without any further act, instrument or deed required from the Amalgamating Company No. 4, and/or the Amalgamated Company and without any approval or acknowledgement of any third party. Further, the Amalgamated Company shall be entitled to the benefit of all claims filed, prosecuted, proposed to be filed, pending and/or adjudicated in relation to all insurance policies issued in respect of the Amalgamating Company No. 4 and/or any of its assets or employees, as the case may be.

(xiii) Upon Part F of the Scheme coming into effect on the Effective Date and with effect from

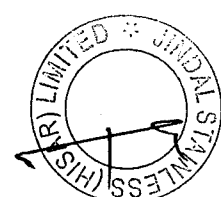
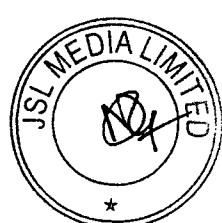
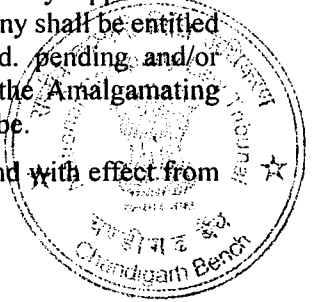
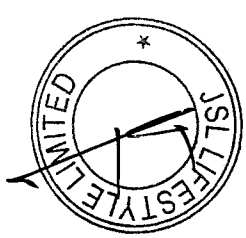

the Appointed Date, immediately after giving effect to Part B of this Scheme, all taxes and duties of whatsoever description (including but not limited all carry forward tax losses comprising of unabsorbed depreciation, advance tax payments, TDS, TCS, MAT, securities transaction tax, taxes withheld/paid in a foreign country, customs duty, entry tax, value added tax, GST, sales tax, service tax etc.) payable by or refundable to the Amalgamating Company No. 4, including all or any refunds or claims shall be treated as the tax liability or refunds/claims, as the case may be, of the Amalgamated Company, and any tax incentives, advantages, privileges, exemptions, credits, holidays, remissions, reductions etc., as would have been available to the Amalgamating Company No. 4, shall pursuant to this Scheme becoming effective, be available to the Amalgamated Company without any further act, instrument or deed required by either the Amalgamating Company No. 4, or the Amalgamated Company and without any approval or acknowledgement of any third party but in the manner more particularly set out herein below. Upon Part F of the Scheme coming into effect on the Effective Date and with effect from the Appointed Date, immediately after giving effect to Part B of this Scheme, all existing and future incentives, un-availed credits and exemptions, benefit of carried forward losses and other statutory benefits, including in respect of income tax (including MAT), excise (including Modvat/ Cenvat), customs, value added tax, sales tax, service tax to which the Amalgamating Company No. 4, is entitled shall be available to and shall stand transferred and vested in the Amalgamated Company without any further act, instrument or deed required from the Amalgamated Company and/or the Amalgamating Company No. 4 and without any approval or acknowledgement of any third party. Upon Part F of the Scheme coming into effect on the Effective Date and with effect from the Appointed Date immediately after giving effect to Part B of this Scheme, any tax deducted at source deducted by or on behalf of the Amalgamating Company No. 4 until the Effective Date shall be deemed to have been deducted on behalf of the Amalgamated Company.

- (xiv) Upon Part F of the Scheme coming into effect on the Effective Date and with effect from the Appointed Date, immediately after giving effect to Part B of this Scheme, the Amalgamated Company shall be entitled to claim the benefit of any and all corporate approvals and limits as may have already been taken by the Amalgamating Company No. 4, including without limitation, the approvals and limits under Sections 62, 179, 180, 185, 186, 188 etc., of the Act, until the time the same are duly modified by the Amalgamated Company.
- (xv) Upon Part F of the Scheme coming into effect on the Effective Date and with effect from the Appointed Date, immediately after giving effect to Part B of this Scheme, all other estates, assets, rights, title, interests and authorities accrued to and/or acquired by the Amalgamating Company No. 4 shall be deemed to have been accrued to and/or acquired for and on behalf of the Amalgamated Company and shall, upon Part F of this Scheme coming into effect, pursuant to the provisions of the Act, without any further act, instrument or deed be and stand transferred to or vested in and/or be deemed to have been transferred to or vested in the Amalgamated Company to that extent and shall become the estates, assets, right, title, interests and authorities of the Amalgamated Company.
- (xvi) Upon Part F of the Scheme coming into effect on the Effective Date immediately after giving effect to Part B of this Scheme, all books, record files, papers, computer programs, engineering and process information, manuals, data, production methodologies, production plans, designs, catalogues, quotations, websites, cloud storage, sales and advertising material, marketing strategies, list of present and former customers, customer credit information, customer pricing information, and other records whether in physical form or electronic form or in any other form in connection with or relating to the Amalgamating Company No. 4 shall be deemed to have been transferred to or acquired for and on behalf of the Amalgamated Company and shall, upon Part F of this Scheme coming into effect, without any further act, instrument or deed be and stand transferred to

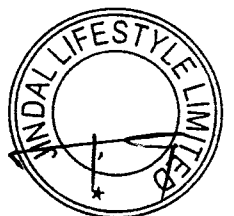
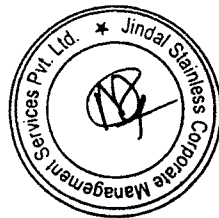
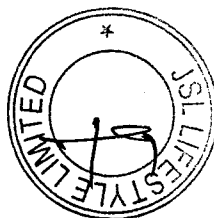
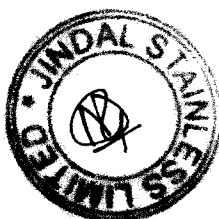
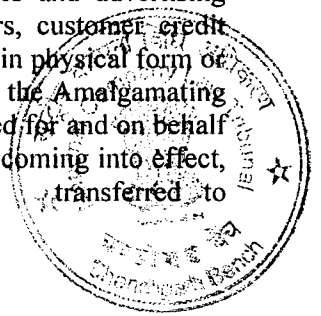

272

or vested in and/or be deemed to have been transferred to or vested in the Amalgamated Company.

(xvii) Upon Part F of the Scheme coming into effect on the Effective Date and with effect from the Appointed Date, immediately after giving effect to Part B of this Scheme, the Amalgamated Company shall bear the burden and the benefits of any legal, tax, quasi-judicial, administrative, regulatory or other proceedings initiated by or against the Amalgamating Company No. 4. If any suit, appeal or other proceeding of whatsoever nature by or against the Amalgamating Company No. 4 shall be pending as on the Effective Date, the same shall not abate, be discontinued or in any way be prejudicially affected by reason of the merger of the Amalgamating Company No. 4, and transfer and vesting of the same in the Amalgamated Company or of anything contained in Part F of this Scheme but the proceedings may be continued, prosecuted and enforced by or against the Amalgamated Company in the same manner and to the same extent as it would or might have been continued, prosecuted and enforced by or against the Amalgamating Company No. 4, as if Part F of this Scheme had not been made effective. Upon Part F of the Scheme becoming effective, the Amalgamated Company undertakes to have such legal or other proceedings initiated by or against the Amalgamating Company No. 4 transferred in its name and to have the same continued, prosecuted and enforced by or against the Amalgamated Company to the exclusion of the Amalgamating Company No. 4. The Amalgamated Company also undertakes to handle all legal or other proceedings which may be initiated against the Amalgamating Company No. 4 after the Effective Date in its own name and account and further undertakes to pay all amounts including interest, penalties, damages etc., pursuant to such legal/ other proceedings.

(xviii) Upon Part F of the Scheme coming into effect on the Effective Date with effect from the Appointed Date, immediately after giving effect to Part B of this Scheme, the Amalgamated Company shall be entitled to the benefit of the past experience, accreditation, and/or performance of the Amalgamating Company No. 4 for all purposes without any further act, instrument or deed required from the Amalgamating Company No. 4 and/or the Amalgamated Company and without any approval or acknowledgement being required from any third party. If any instrument or deed or document is required or deemed necessary or expedient to give effect to the provisions of this Clause by the Amalgamated Company, the Amalgamated Company shall, under the provisions of Part F of the Scheme, be deemed to be duly authorized to execute all such writings on behalf of the Amalgamating Company No. 4 and to carry out or perform all such formalities or compliances referred to above on behalf of the Amalgamating Company No. 4.

48 AMENDMENT TO OBJECTS OF THE AMALGAMATED COMPANY

48.1 Upon Part F of the Scheme becoming effective from the Effective Date immediately after coming into effect of Part B of this Scheme, the following sub-clause shall be deemed to have been automatically added to Clause III (A) (Main Objects) of the Memorandum of Association of the Amalgamated Company immediately after the existing sub-clauses of Clause III (A) and the "Objects Clause" in the Memorandum of Association of the Amalgamated Company shall be deemed to have been amended to that extent by inserting below clauses in the main objects of the Amalgamated Company:-

"To enable companies, firms, other bodies corporate and/or individual(s), to avail and share common facilities and resources of or provided by the company from time to time with a view to optimize the benefits of specialization and to achieve economies of scale and to rationalize costs of each such companies/entities."

It is hereby clarified that the consent of the shareholders of the Amalgamated Company and the shareholders of the Amalgamating Companies to Part F of this Scheme shall be sufficient for the purposes of effecting the aforesaid amendments in the "Objects Clause" in the Memorandum of

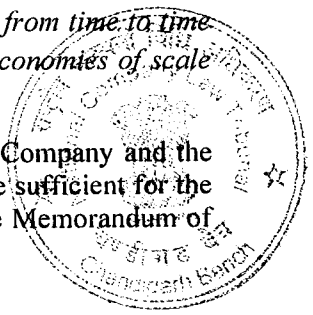
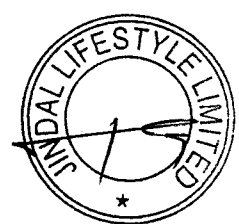
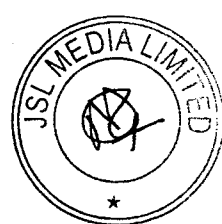
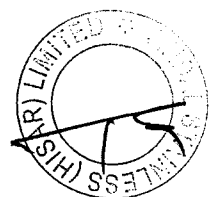
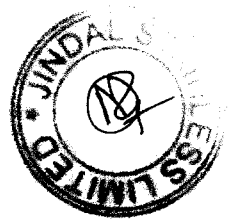
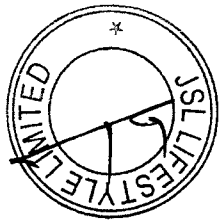

Association of the Amalgamated Company and no further resolutions, under the applicable provisions of the Act, shall be required to be separately passed. All actions taken in accordance with this Clause shall be deemed to be in full compliance of Section 13 and other applicable provisions of the Act and rules and regulations issued thereunder and no further resolutions or actions under any other provisions of the Act or the rules or regulations issued thereunder would be required to be separately passed or undertaken by the Amalgamated Company.

49 CONDUCT OF AFFAIRS UNTIL THE EFFECTIVE DATE

49.1 In the event Part F of this Scheme becomes effective and with effect from the Appointed Date and up to and including the Effective Date:

- (i) the Amalgamating Company No. 4 shall be deemed to have carried on the business activities of the Amalgamating Company No. 4 and stand possessed of the properties and assets of the Amalgamating Company No. 4, for, on behalf of and in trust for, the Amalgamated Company; and
- (ii) all profits or income accruing to or received by the Amalgamating Company No. 4 and all taxes paid thereon (including but not limited to advance tax, tax deducted at source, tax collected at source, minimum alternate tax, fringe benefit tax, securities transaction tax, taxes withheld/paid in a foreign country, customs duty, entry tax, value added tax, goods and services tax, sales tax, service tax etc.) or losses arising in or incurred by the Amalgamating Company No. 4 shall, for all purposes, be treated as and deemed to be the profits, income, taxes or losses, as the case may be, of the Amalgamated Company.

49.2 The Amalgamated Company shall also be entitled, pending the sanction of this Scheme, to apply to the central government, state government and all other agencies, departments, statutory authorities and Governmental Authorities concerned, wherever necessary, for such consents, approvals and sanctions which the Amalgamated Company may require including the registration, approvals, exemptions, reliefs, etc., as may be required/granted under any Applicable Law for the time being in force for carrying on the business of the Amalgamating Company No. 4.

50 TREATMENT OF TAXES

50.1 Upon Part F of this Scheme becoming effective and with effect from the Appointed Date immediately after giving effect to Part B of this Scheme, any surplus in the provision for taxation/ duties/ levies account including but not limited to, the advance tax, TDS or TCS and MAT credit, CENVAT credit, or, GST Credit, as on the date immediately preceding the Appointed Date will also be transferred from the Amalgamating Company No. 4 to the Amalgamated Company. Any refund under the IT Act or other Applicable Laws dealing with taxes/ duties/ levies, including GST, allocable or related to the business of Amalgamating Company No. 4 or due to the Amalgamating Company No. 4 consequent to the assessment made in respect of Amalgamating Company No. 4, for which no credit is taken in the book of accounts of the Amalgamating Company No. 4 as on the date immediately preceding the Appointed Date, shall also belong to and be received by the Amalgamated Company and shall be deemed to have been on account of or paid by the Amalgamated Company and the relevant Governmental Authorities shall be bound to transfer to the account of and give credit for the same, to the Amalgamated Company upon the approval of this Scheme by the Court and upon relevant proof and documents being provided to the said authorities.

50.2 Without prejudice to the generality of the above, deductions, benefits, right to carry forward and set off accumulated losses and unabsorbed depreciation, and credits (including but not limited to MAT/CENVAT credits etc.) under the IT Act, Goods and Services Tax or Service Tax, any other central government/state government incentive schemes etc., to which the Amalgamating Company No. 4 is / would be entitled to in terms of the Applicable Laws of the central or state government or of any foreign jurisdictions, shall be available to and vest in the Amalgamated Company.

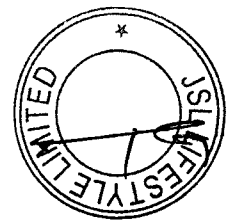
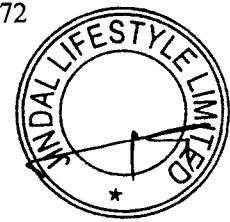
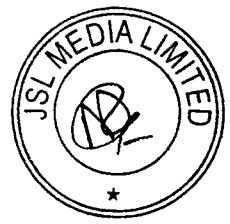
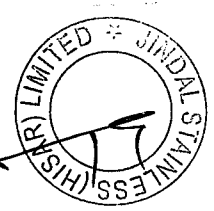
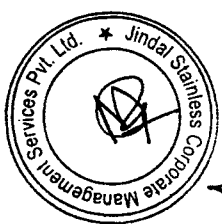
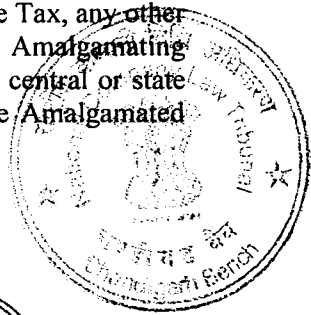

273

- 50.3 Upon Part F of this Scheme becoming effective and with effect from the Appointed Date immediately after giving effect to Part B of this Scheme, the tax payments (including without limitation income tax, GST, tax on distribution of dividends, excise duty, central sales tax, custom duty, applicable state value added tax and entry tax or any other taxes as may be applicable from time to time) whether by way of tax deducted at source or collected at source by the parties, advance tax or otherwise howsoever, by the Amalgamating Company No. 4 on or after the Appointed Date, shall be deemed to be paid by the Amalgamated Company and the Amalgamated Company shall be entitled to claim credit for such taxes/duties paid against its tax/ duty liabilities, notwithstanding that the certificates/ challans or other documents for payment of such taxes/duties are in the name of Amalgamating Company No. 4.
- 50.4 Upon Part F of the Scheme becoming effective on the Effective Date and with effect from the Appointed Date immediately after giving effect to Part B of this Scheme, the Amalgamating Company No. 4 and the Amalgamated Company are expressly permitted to prepare and/or revise, as the case may be, their financial statements and statutory / Tax returns along with the prescribed forms, filings and annexures under the IT Act and/or in relation to central sales tax, custom duty, entry tax, applicable state value added tax, GST and other tax laws, if required, to give effect to the provisions of the Scheme.
- 50.5 Upon Part F of the Scheme being effective on the Effective Date, with effect from the Appointed Date immediately after giving effect to Part B of this Scheme, all inter-party transactions between Amalgamating Company No. 4 and the Amalgamated Company shall be considered as intra-party transactions for all purposes (including for tax compliances, credits, refunds, etc.).
- 50.6 Upon Part F of the Scheme being effective on the Effective Date immediately after giving effect to Part B of this Scheme, obligation for deduction of tax at source on any payment made by or to be made by the Amalgamating Company No. 4 or for collection of tax at source on any supplies made by or to be made by the Amalgamating Company No. 4 shall be made or deemed to have been made and duly complied with by the Amalgamated Company. Further, any tax deducted at source or collected at source by the Amalgamating Company No. 4 and the Amalgamated Company on transactions with each other, if any (from the Appointed Date until Effective Date) and deposited with the Governmental Authorities shall be deemed to be advance tax paid by the Amalgamated Company and shall, in all proceedings be dealt with accordingly.
- 50.7 Upon Part F of the Scheme coming into effect on the Effective Date and with effect from the Appointed Date immediately after giving effect to Part B of this Scheme, all tax compliances under any tax laws by the Amalgamating Company No. 4 on or after the Appointed Date shall be deemed to be made by the Amalgamated Company.
- 50.8 Upon Part F of the Scheme coming into effect on the Effective Date with effect from the Appointed Date immediately after giving effect to Part B of this Scheme, all tax assessment proceedings and appeals of whatsoever nature by or against the Amalgamating Company No. 4, pending or arising as at the Effective Date, shall be continued and/enforced by or against the Amalgamated Company in the same manner and to the same extent as would or might have been continued and enforced by or against the Amalgamating Company No. 4. Further, the aforementioned proceedings shall neither abate or be discontinued nor be in any way prejudicially affected by the reason of the amalgamation of the Amalgamating Company No. 4 with the Amalgamated Company or anything contained in Part F of this Scheme.
- 50.9 Upon Part F of the Scheme coming into effect on the Effective Date with effect from the Appointed Date immediately after giving effect to Part B of this Scheme, all the expenses incurred by the Amalgamating Company No. 4 and the Amalgamated Company in relation to the amalgamation of the Amalgamating Company No. 4 with the Amalgamated Company as per this Scheme, including stamp duty expenses and / or transfer charges, if any, shall be allowed as deduction to Amalgamated Company in accordance with Section 35DD of the IT Act over a

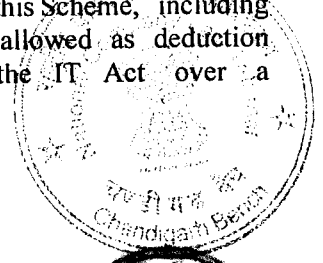
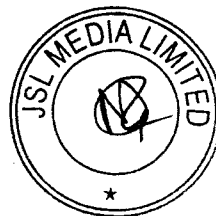
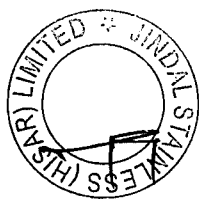
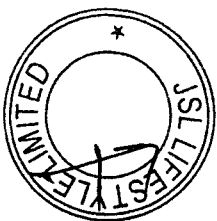
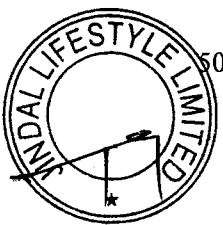

period of 5 (five) years beginning with the previous year in which Part F of the Scheme becomes effective.

- 50.10 With effect from the Appointed Date, all the deductions otherwise admissible to the Amalgamating Company No. 4, including payment admissible on actual payment or on deduction of appropriate taxes or on payment of TDS (like Section 43B, Section 40, Section 40A, etc. of the IT Act) will be eligible for deduction to the Amalgamated Company upon fulfilment of required conditions under the IT Act.
- 50.11 The amalgamation under this Scheme is in compliance with the IT Act, specifically Section 2(1B) and other relevant provisions. If any of the terms of this Scheme are inconsistent with the provisions of Sections 2(1B) of the IT Act, the provisions of Sections 2(1B) of the IT Act shall to the extent of such inconsistency, prevail and this the Scheme shall, stand and be deemed to be modified to that extent to comply with the said provisions and such modifications shall not affect the other Parts of this Scheme.

51 CONDUCT OF AFFAIRS AFTER THE EFFECTIVE DATE

51.1 The Amalgamated Company, shall, at any time after Part F of this Scheme becomes effective on the Effective Date immediately after giving effect to Part B of this Scheme, in accordance with the provisions hereof, if so required under any law, contract or otherwise, be entitled to do and take all such actions as may be required to give full effect to the provisions of this Part F and for this purpose the Amalgamated Company shall, under the provisions hereof, be deemed to be authorised on behalf of Amalgamating Company No. 4. Without prejudice to the generality of the above, the Amalgamated Company shall be entitled and deemed to be authorised to:-

- (i) execute appropriate deeds of confirmation or other writings or arrangements with any party to any contract or arrangement (including without limitation any bank guarantee, performance guarantee, fixed deposit, letters of credit, bill of entry etc.) in relation to which the Amalgamating Company No. 4 have been a party or to the benefit of which the Amalgamating Company No. 4 may have been entitled, and to make any filings with the Governmental Authorities, in order to give formal effect to the provisions of Part F of the Scheme; and
- (ii) do all such respective acts or things as may be necessary to effectually transfer/obtain in favour of the Amalgamated Company the approvals, consents, bids, awards, tenders, exemptions, registrations, no-objection certificates, permits, quotas, rights, entitlements, licenses and certificates etc. which were held or enjoyed by the Amalgamating Company No. 4 including without limitation, execute all necessary or desirable writings and confirmations on behalf of Amalgamating Company No. 4 and to carry out and perform all such acts, formalities and compliances as may be required in this regard.

51.2 The provisions of this Clause shall operate notwithstanding anything to the contrary contained in any deed or writing or certificate or license or the terms of sanction or issue or any security, all of which instruments and documents shall stand modified and/or superseded by the foregoing provisions.

SAVING OF CONCLUDED TRANSACTIONS

Except as expressly provided hereunder including in Clause 50.4 and Clause 50.5, the transfer of properties and liabilities to, and the continuance of proceedings by or against, the Amalgamated Company as envisaged in this Part F shall not affect any transaction or proceedings already concluded by the Amalgamating Company No. 4, on or before the Appointed Date and after the Appointed Date and until the Effective Date, and to such end and intent the Amalgamated Company accepts and adopts all acts, deeds and things done and executed by the Amalgamating

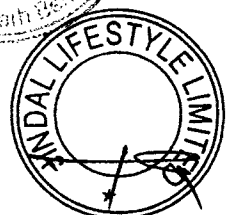
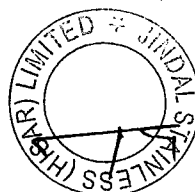
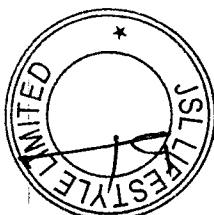
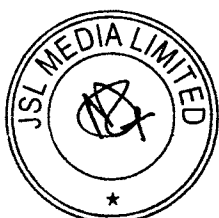
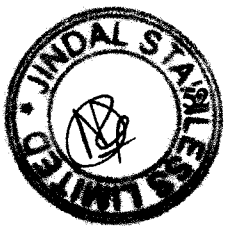

276

Company No. 4 in respect thereto as done and executed on behalf of itself.

53 DISCHARGE OF CONSIDERATION

- 53.1 Upon Part B of this Scheme coming into effect on the Effective Date, the Amalgamating Company No. 4 which is currently jointly owned by the Amalgamated Company and the Amalgamating Company No. 1, will become a wholly owned subsidiary of the Amalgamated Company, hence no further shares of the Amalgamated Company will be issued upon amalgamation of Amalgamating Company No. 4 into and with the Amalgamated Company.
- 53.2 The Board of Directors (including any committee thereof) of the Amalgamating Company No. 4 and the Amalgamated Company shall be empowered to remove such difficulties as may arise in the course of implementation of this Scheme.

54 DISSOLUTION OF AMALGAMATING COMPANY NO. 4

- 54.1 Upon Part F of this Scheme becoming effective on the Effective Date, the Amalgamating Company No. 4 shall stand automatically dissolved as an integral part of this Scheme, without being liquidated or wound-up and without requiring any further act, instrument or deed from the Amalgamating No. 4 and/or the Amalgamated Company.

55 ACCOUNTING TREATMENT

- 55.1 Upon Part F of the Scheme becoming effective, with effect from the Appointed Date, the Amalgamated Company shall account for the amalgamation in its books of accounts, as per 'Acquisition Method' in accordance with accounting principles as laid down in Ind AS-103 notified under Section 133 of the Act and under the Companies (Indian Accounting Standards) Rules, 2015, as may be amended from time to time, such that:
 - (i) In line with the recognition principles provided under Indian Accounting Standard 103 on Business Combinations, the Amalgamated Company shall recognise all assets and liabilities of the Amalgamating Company No. 4 transferred to and vested in the Amalgamated Company pursuant to this Scheme at their respective fair values as on the Appointed Date. Such assets may also include acquired identifiable intangible assets, whether previously recorded in the books of accounts of the Amalgamating Company No. 4 or not. Upon the Part F of the Scheme coming into effect, the above recognition shall result in the Amalgamated Company recording all the assets and liabilities of the Amalgamating Company No. 4 transferred to and vested in it pursuant to this Scheme.
 - (ii) Investment held by Amalgamated Company and Amalgamating Company No. 1 in the Amalgamating Company No. 4 shall be cancelled.
 - (iii) Inter-company balances between the Amalgamated Company and the Amalgamating Company No. 4, if any, shall stand cancelled and there shall be no further obligation in that behalf.
 - (iv) Excess, if any, of investment cancelled as per sub-Clause (ii) above over the fair value of net assets taken over as per sub-Clause (i) above, after giving the effect to Clause sub-(iii) above, shall be recorded as goodwill. In case of deficit, it shall be credited to capital reserve account.

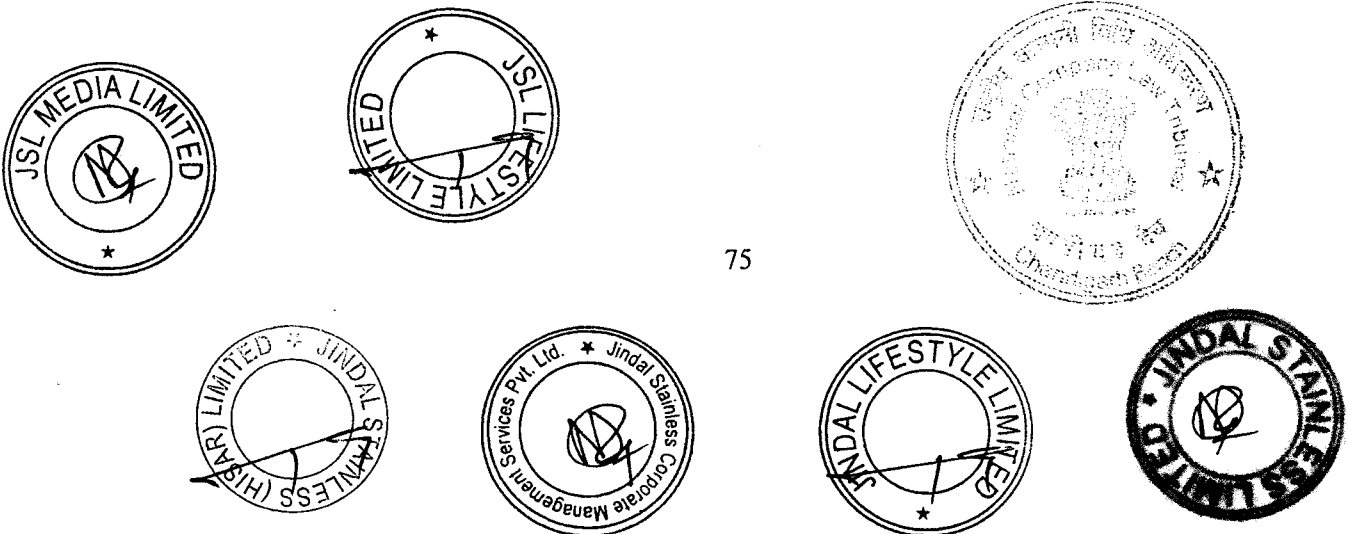

277

PART G
GENERAL TERMS AND CONDITIONS

56 CONDITIONALITY OF THE SCHEME

- 56.1 The effectiveness of Part B, Part C, Part D, Part E and Part F of this Scheme is conditional upon and subject to the following:
- (a) this Scheme being approved by the requisite majorities of such classes of shareholders and creditors of the Companies as may be required under Applicable Laws or as may be directed by the Court;
 - (b) receipt of an 'Observation Letter' or a 'No-objection Letter' from the designated stock exchange on the Scheme, as required under Applicable Laws;
 - (c) this Scheme being approved by the shareholders of the Amalgamated Company and the Amalgamating Company No. 1 through a special resolution and provided that the votes cast by their respective public shareholders in favour of the Scheme are more than the number of votes cast by their respective public shareholders against it, through e-voting in terms of Para (A)(10)(b) of Part I of the SEBI Circular;
 - (d) the sanction of such Part of the Scheme by the Court;
 - (e) the receipt of such other approvals including approvals of any Governmental Authority as may be necessary under Applicable Laws or under any material contract to make this Scheme or the relevant Part of this Scheme effective; and
 - (f) the certified copies of the order of the Court sanctioning this Scheme (wholly or partially) being filed with the Registrar of Companies by each of the relevant Companies.
- 56.2 Additionally, the effectiveness of Part C, Part E and Part F of this Scheme is conditional upon and subject to Part B of this Scheme becoming effective and the effectiveness of Part D of this Scheme is conditional upon and subject to Part B and Part C of this Scheme becoming effective. Provided however, Part B of this Scheme is not conditional upon any other Part of this Scheme becoming effective.

57 EFFECTIVENESS OF THE SCHEME

Subject to Clause 56 of this Scheme, upon this Scheme becoming effective on the Effective Date, the following shall be deemed to have occurred on the Appointed Date and shall become effective and operative in the sequence and in the order mentioned hereunder:

- (i) Amalgamation of Amalgamating Company No. 1 into and with the Amalgamated Company in accordance with Part B of this Scheme;
- (ii) Demerger of the Demerged Undertaking of the Demerged Company and vesting of the same with and into the Resulting Company in accordance with Part C of this Scheme;
- (iii) Amalgamation of the Amalgamating Company No. 2 into and with Amalgamated Company in accordance with Part D of this Scheme;
- (iv) Amalgamation of Amalgamating Company No. 3 into and with Amalgamated Company in accordance with Part E of this Scheme; and
- (v) Amalgamation of Amalgamating Company No. 4 into and with Amalgamated Company in accordance with Part F of this Scheme.

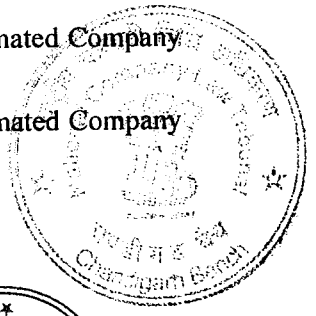
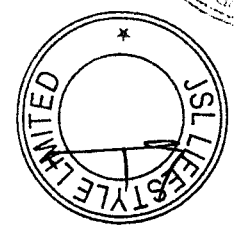
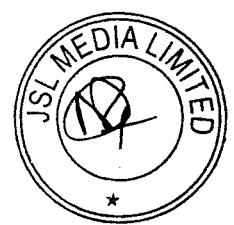
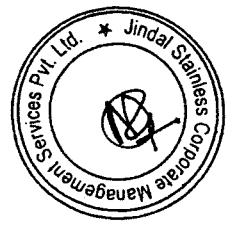
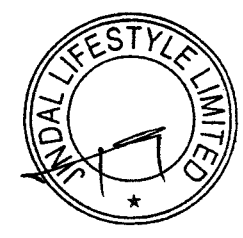
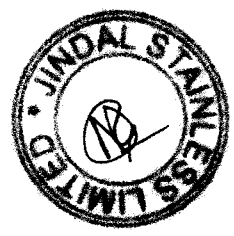

278

58 APPLICATIONS TO THE COURT

- 58.1 Subject to Clause 56.1(b), Clause 59 and Clause 60 of this Scheme, the Companies shall, with all reasonable dispatch, make a joint application to the Court, under Sections 230 to 232 read with Section 66 and other applicable provisions of the Act, seeking orders for dispensing with or convening of the meetings of the different classes of their respective shareholders and/or creditors and for sanctioning this Scheme with such modifications, as may be approved/required by the SEBI, the Court or any other Governmental Authority.
- 58.2 Subject to Clause 56.1(b), Clause 59 and Clause 60 of this Scheme, upon this Scheme being approved by the requisite majority of the shareholders and creditors of the Companies (wherever required), the Companies shall, file a joint petition before the Court for sanction of this Scheme under Sections 230 to 232 read with Section 66 and other applicable provisions of the Act, and for such other order or orders, as the Court may deem fit for bringing this Scheme into effect. Upon this Scheme becoming effective, the shareholders and the creditors of the Companies shall be deemed to have also accorded their approval under all relevant provisions of the Act for giving effect to the specific provisions contained in this Scheme.

59 MODIFICATIONS/AMENDMENTS TO THE SCHEME

- 59.1 The Companies, acting through their respective Boards of Directors, may assent to any modifications or amendments to this Scheme, which the Court, SEBI and/or any other Governmental Authorities may deem fit to direct or impose, or which may otherwise be considered necessary or desirable for settling any question or doubt or difficulty that may arise in implementing and/or carrying out this Scheme provided however that no modification to the Scheme will be made which adversely affects the rights or interest of the secured creditors without seeking their approval. The Companies, acting through their respective Boards of Directors, be and are hereby authorised to take all such steps and do all acts, deeds and things as may be necessary, desirable or proper to give effect to this Scheme and to resolve any doubts, difficulties or questions, whether by reason of any orders of the Court or of any directive or orders of SEBI or any other Governmental Authorities or otherwise howsoever, arising, out of, under, or by virtue of this Scheme and/or any matters related to or connected therewith.
- 59.2 If, at any time, before or after the Effective Date, any provisions or Parts of this Scheme are found to be, or interpreted to be, invalid or illegal or inconsistent with any Applicable Laws, or rejected, or unreasonably delayed, or not sanctioned by the Court, or is or becomes unenforceable, under present or future Applicable Laws, or due to any change in any Applicable Laws, then it is the intention of the Companies that such part shall be severable from the remainder of this Scheme and subject to Clause 56.2 other Parts / provisions of this Scheme shall not be affected thereby, unless the deletion of such Part shall cause this Scheme to become materially adverse to any of the Companies in the sole opinion of the Board of Directors of the relevant Companies. In such a case, the Companies, acting through their respective Boards of Directors, may at their discretion, either bring about such modification in this Scheme, as is likely to best preserve for the relevant Companies, the benefits and obligations of this Scheme and/or withdraw the Scheme or any Part thereof, wholly or partially.

59.3 The Companies, acting through their respective Boards of Directors, shall each be at liberty to withdraw this Scheme, wholly or partially, in case any condition or alteration imposed by the Court, SEBI or any other Governmental Authority is unacceptable to any of them or otherwise if so decided by their respective Board of Directors. In the event any Parts or provisions of this Scheme are withdrawn and the Companies decide to implement the remaining Parts or provisions of this Scheme, to the extent of such withdrawn provisions, this Scheme shall become null and void and no rights or liabilities whatsoever shall accrue to, or be incurred by, the relevant Companies, their respective shareholders and/or creditors and/or any other persons with respect to such provisions or Parts of the Scheme.

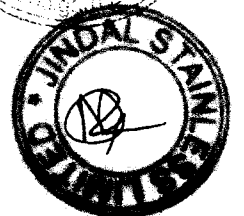
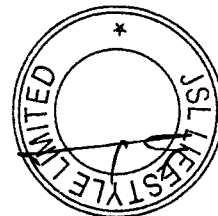
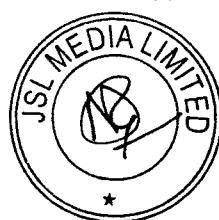
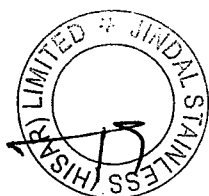
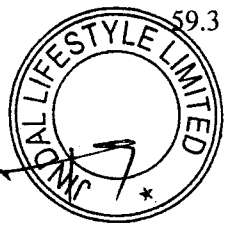

279

60 EFFECT OF NON-RECEIPT OF APPROVALS/SEVERABILITY

60.1 In the event any of the sanctions, consents or approvals referred to in Clause 56 above are not obtained or received and/or the Scheme, or any Part thereof, has not been sanctioned by the Court, the Board of Directors of each of the Companies, shall, by mutual agreement, determine whether:

- (a) this Scheme shall stand revoked and cancelled in entirety and shall be of no effect, save and except in respect of any act or deed done prior thereto as is contemplated hereunder or as to any rights and/or liabilities which might have arisen or accrued pursuant thereto and which shall be governed and be preserved or worked out as is specifically provided in the Scheme or under Applicable Law and in such event, each Company shall bear and pay its respective costs, charges and expenses for and in connection with the Scheme; or
- (b) such Part shall be severable from the remainder of the Scheme and the remainder of the Scheme shall not be affected thereby, unless the deletion of such Part shall cause the Scheme to become materially adverse to any Company, in which case each of the Companies, (acting through their respective Boards of Directors) shall attempt to bring about a modification in the Scheme, as will best preserve for the Companies, the benefits and obligations of this Scheme, including but not limited to such Part. Provided, however, that no modification to the Scheme shall be made which adversely affects the rights or interests of the secured creditors, without seeking their approvals.

60.2 For the avoidance of doubt, it is clarified that, notwithstanding the above, the non-receipt of any sanctions, consents or approvals in connection with (a) Part C, Part D, Part E and/or Part F of the Scheme, either individually or collectively, shall not affect the effectiveness of Part B of the Scheme; (b) Part C and/or Part D of the Scheme, either individually or collectively, shall not affect the effectiveness of Part E and/or Part F of the Scheme; and (c) Part E and/or Part F of the Scheme, either individually or collectively, shall not affect the effectiveness of Part C and/or Part D of the Scheme.

61 COMPLIANCE WITH LAWS

61.1 This Scheme is presented and drawn up to comply with the provisions/requirements of Sections 230 to 232 read with Section 66 and other applicable provisions of the Act, for the purpose of (a) amalgamation of the Amalgamating Company No. 1 into and with the Amalgamated Company; (b) demerger of the Demerged Undertaking of the Demerged Company and vesting of the same into the Resulting Company; (c) amalgamation of Amalgamating Company No. 2 into and with the Amalgamated Company; (d) amalgamation of Amalgamating Company No. 3 into and with the Amalgamated Company; and (e) amalgamation of the Amalgamating Company No. 4 into and with the Amalgamated Company; and other actions incidental or connected therewith.

61.2 This Scheme has been drawn up to comply with the conditions relating to (a) "amalgamation" with respect to Part B, Part D, Part E and Part F of the Scheme; and (b) "demerger" with respect to Part C of the Scheme, as defined under Section 2(1B) and 2(19AA) of the IT Act, respectively.

61.3 The Companies undertake to comply with all Applicable Laws, including all applicable compliances required by the SEBI and the Stock Exchanges and all applicable compliances required under the Foreign Exchange Management Act, 1999, including making the requisite intimations and disclosures to any statutory or regulatory authority and obtaining the requisite consent, approval or permission of the Central Government, RBI (if required) or any other statutory or regulatory authority, which by Applicable Law may be required for the implementation of this Scheme.

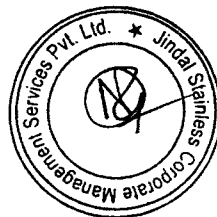
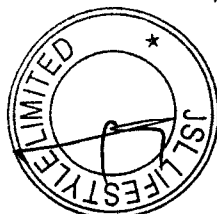
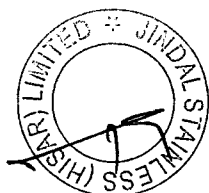
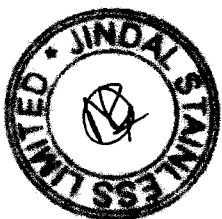
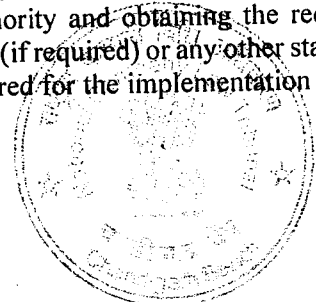
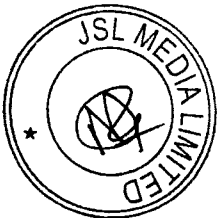

280

62 CANCELLATION OF INTER-SE TRANSACTIONS

Upon this Scheme becoming effective on the Effective Date and with effect from the Appointed Date, all loans, advances, trade receivables and other obligations or liabilities due, from or by or any guarantees given on behalf, any of the Amalgamating Companies to or for each other or to the Amalgamated Company or *vice versa*, if any, and all contracts, arrangements and transactions, of any nature whatsoever, between any of the Amalgamating Companies and the Amalgamated Company (other than this Scheme) shall stand automatically cancelled and terminated and shall be of no effect, without any further act, instrument or deed being required from any of the Companies and without any approval or acknowledgement of any third party. No further taxes, fees, duties or charges shall be required to be paid by the Amalgamated Company on account of such cancellation or termination.

63 CAPITAL AND DIVIDENDS

- 63.1 Nothing in this Scheme shall be interpreted to restrict the ability of any of the Companies to declare and/or pay dividends, whether interim and/or final or issue bonus shares, to their respective shareholders prior to the Effective Date.
- 63.2 It is clarified that the aforesaid provisions in respect of declaration of dividends are enabling provisions only and shall not be deemed to confer any right on any shareholder of the Companies to demand or claim any dividends which, subject to the provisions of the Act, shall be entirely at the discretion of the respective Boards of Directors of the Companies, and if applicable as per the provisions of the Act, shall also be subject to the approval of the shareholders of the relevant Company or Companies.
- 63.3 Nothing in this Scheme shall be interpreted to restrict the ability of any of the Companies to raise capital or funds whether by way of equity or debt, in any manner whatsoever, at any time prior to the Effective Date.

64 COSTS

- 64.1 All costs, charges, taxes including stamp duty, levies and all other expenses, if any (save as expressly otherwise agreed) of the Amalgamating Companies arising out of or incurred in connection with implementing Part B, Part D, Part E and/or Part F of this Scheme and matters incidental thereto shall be borne by the Amalgamated Company.
- 64.2 All costs, charges, taxes including stamp duty, levies and all other expenses, if any (save as expressly otherwise agreed) of the Demerged Company in relation to the Demerged Undertaking arising out of or incurred in connection with implementing Part C of this Scheme and matters incidental thereto shall be borne by the Resulting Company.

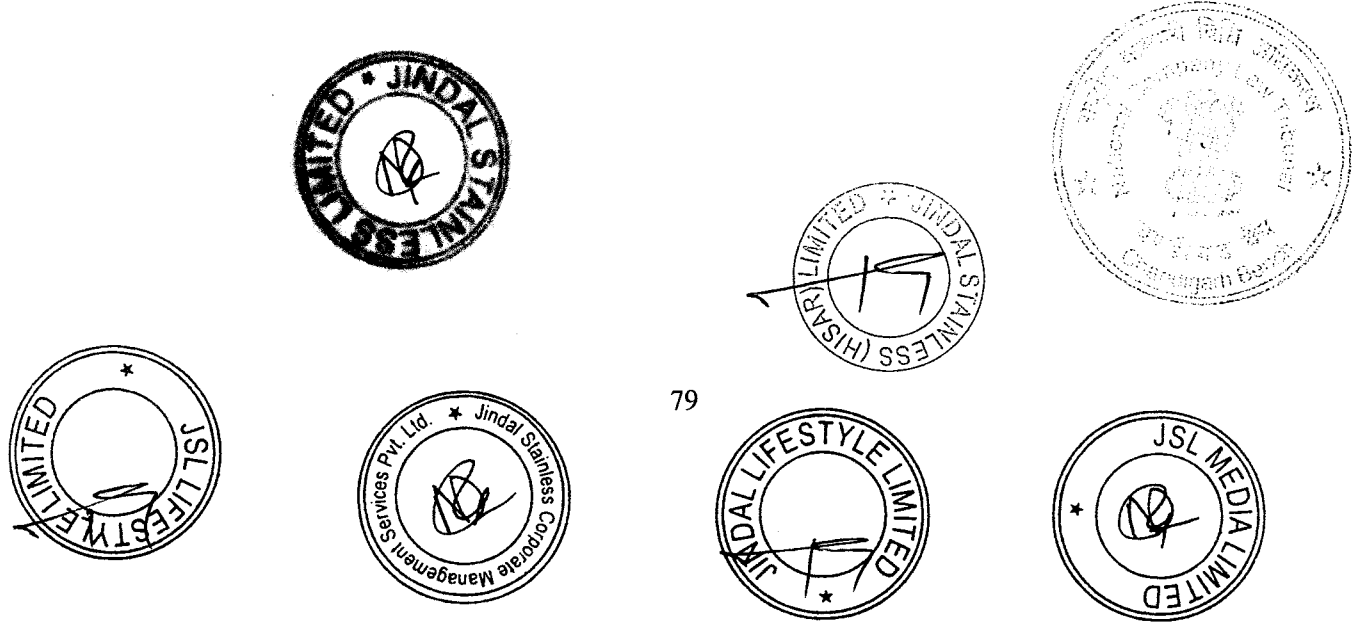

281

SCHEDULE 1 – DETAILS OF IMMOVABLE PROPERTIES OF AMALGAMATING COMPANY NO. 1

1. Immovable Properties situated at Hisar, Haryana
 - i. Land admeasuring 2787 Kanals and 07 Marlas (348 Acres 03 Kanal 07 Marla) situated in various villages in the district of Hisar, in the state of Haryana together with all buildings and structures thereon and all plant and machinery attached to the earth or permanently fastened to anything attached to the earth.
 - ii. Land admeasuring approx. 36 Kanals 16 Marlas in aggregate, situated in village Satrod Khas, Tehsil and district, Hisar, together with all buildings, erections and constructions of every description which are standing, erected or attached thereto.
2. Immovable Properties situated at Gurugram
 - i. Land admeasuring 4050 Sq. Meters, situated at Institutional Plot No. 50-P, Sector – 32, in District Gurugram in the State of Haryana, together with all buildings, erections and constructions of every description which are standing, erected or attached thereto.

CERTIFIED TO BE TRUE COPY OF THE ORIGINAL

FREE OF COST COPY

No. 516
 Date of presentation of application for Copy 13.02.03
 No. of pages 126 pages
 Copy fee Nil
 Registration Fee Nil
 Total Nil
 Date of issue of Copy 16.02.03
 Date of receipt of Copy 17.02.03

NOTARY PUBLIC Court Office,
 National Company Law Tribunal
 Chandigarh Bench, Chandigarh

